

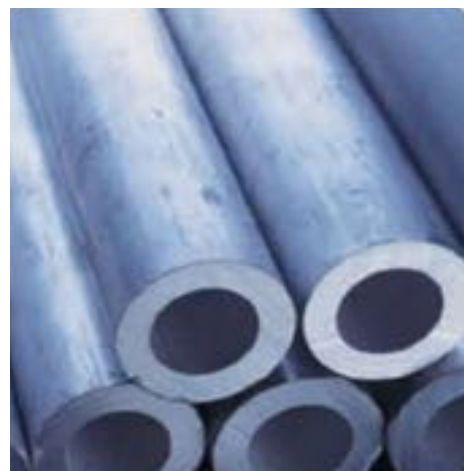

Product Reference Manual

www.atlassteels.com.au



Atlas Steels a division of Atlas Specialty Metals - ABN 29 616 786 648 - www.atlassteels.com.au

July 2020

Contents



SECTION

1	Conducting Business with Atlas Steels
2	Stainless Steel Sheet, Coil and Plate
3	Stainless Steel Pipe, Fittings and Flanges
4	Stainless Steel Tube and Fittings
5	Carbon Steel Pipe, Fittings and Flanges
6	Stainless Steel Bar (Round, Flat, Angle, Sections)
7	Aluminium Sheet, Coil, Plate and Treadplate
8	Atlas AlFacade
9	Appendices

Conducting Business with Atlas Steels

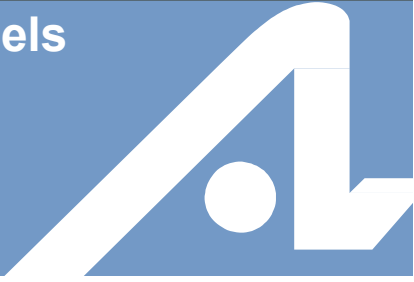

1 Conducting business with Atlas Steels



1

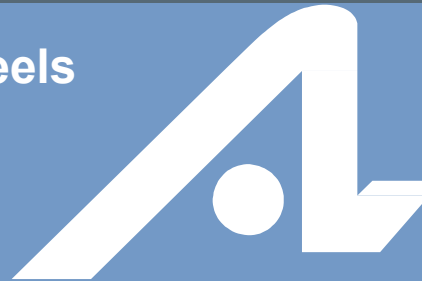

Welcome to Atlas Steels, the leading stockist and distributor of stainless steels and special metals across Australia.

This Reference Manual provides information on the range and grades of stainless and special metals we distribute. It also contains general technical information that may be of interest to users and outlines the processing facilities and services provided to our customers.

Atlas Steels the Company

In 1918 Atlas Steels began the manufacturing of tool steels in Canada and by 1938 was the major producer of tool and specialty steels in the country. In the years since 1918 many of the businesses that Atlas started world-wide have been absorbed into other companies and today the only one still remaining and maintaining the Atlas name in the specialty metals industry is the Australian offshoot, which evolved from the Canadian parent when they established operations in Australia in 1939.

In many respects the Atlas of today with operations across Australia remains true to the vision of its forefathers and still retains its focus and strength in specialty metals but with a larger products base in stainless steels, alloy steels, aluminium and carbon steels in specialised applications.

The Atlas of today is a private company with a distribution and warehousing network across Australia's major cities and regional centres.

For more information about Atlas, please visit our website at www.atlassteels.com.au

Conducting Business with Atlas Steels

Atlas, over many years of participation in the specialty metals industry, has built a level of knowledge and expertise that has helped to build the company to be the largest in its market and offer superior customer service. We do this by providing:

- A comprehensive range of specialty metal products
- Locations across Australian capital cities and regional centres
- Personnel who can readily understand the specific needs of product users
- Nationally integrated, computer-based stocking and inventory control systems
- Extensive global product sourcing network from reputable mills
- Warehouse facilities, systems and procedures that cater to the needs of processing and handling specialty metals
- A company-wide quality system accredited to ISO9001
- Trained technical support personnel
- Project services dedicated to supplying products to major resource and infrastructure projects in any region of the world

There is limited production of specialty metals in Australia with the majority being imported from overseas mills. Because of this it is most important that users have a high level of confidence in the product and services supplied by specialty metals stockists/distributors.

Atlas has, through years of participation in the industry, established a network of reputable mill suppliers to service its customers. These mills have been chosen following a rigorous selection process based on Atlas criteria of mill adherence to strict quality standards, history of reliable supply and support for product in the field.

Atlas supports its customers and suppliers with experienced technical personnel and sales personnel trained extensively to understand the product qualities and applications associated with specialty metals.

Atlas Steels Website

The Atlas Steels website at www.atlassteels.com.au is the principle window into Atlas. In addition to profiling our products and the services we offer, the website includes the full contents of this Product Reference Manual in down-loadable PDF format.

A feature of the Atlas Steels website is the “Technical Library”. This includes:

- Technical Handbook of Stainless Steel
- Technical Notes covering frequently asked questions
- Datasheets on most grades handled by Atlas
- Calculation spreadsheets for PREN, Carbon Equivalent and product weight
- Tables to assist with unit conversions
- Pressure rating charts for pipe and tube

All these resources are available for free download.

If there is a Product Problem

At Atlas we strive to provide product that both complies with all appropriate specifications and meets the requirements of our customers. Despite this, occasionally there are real or perceived problems.

To help resolve the concern we ask that:

1. Contact Atlas as soon as it is apparent that there is a problem; do not wait until the full extent and severity are known.
2. Please tell us before trying to fix any serious problem. Claims for extra costs may be difficult to establish.
3. Maintain Atlas delivery and Trace/Heat Number.
4. Keep samples of the original product showing the problem and also if possible the original mill identification markings.
5. Retain details of manufacturing operations that revealed the problem. Sketches, photographs and drawings may be useful in understanding the problem.

Make use of Atlas’ technical assistance service at time of purchase of product; careful specification at this stage may avoid later problems.

Terms and Conditions of Sale

Refer to www.atlassteels.com.au

Limitation of Liability

The information contained in this manual is not intended to be an exhaustive statement of all relevant data applicable to special and general metal products. It has been designed as a guide for customers to the products and service Atlas Steels can offer. No responsibility is implied or accepted for or in conjunction with quality or standard of any product or its suitability for any purpose or use.

It is the responsibility of the user to ensure product specified is fit for the purpose intended.

All conditions, warranties, obligations and liabilities of any kind which are or may be implied or imposed to the contrary by any statute, rule or regulation or under the general law and whether arising from the negligence of the company, its servants or otherwise are hereby excluded except to the extent that the company may be prevented by any statute, rule or regulation from doing so.

The Grades and Properties of Stainless Steel

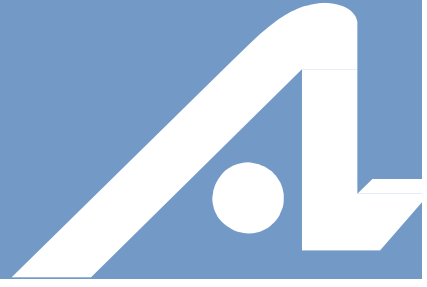

Introduction

The group of alloys which today make up the family of stainless steels had their beginnings in 1912 in Sheffield, England. Harry Brearley was testing a number of alloys for possible gun barrel steels and observed that samples cut from one of these trial heats did not rust. Upon investigation it was shown to contain 13% chromium and this discovery led to the development of stainless for use in cutlery, for which Sheffield became famous. Coincidentally, at about the same time, development work was also being carried out in France and Germany, which resulted in the production of the first austenitic stainless steel.

The Families of Stainless Steel

Stainless steels are iron-based alloys containing a minimum of about 10.5% chromium. The chromium forms a protective self-healing oxide film, which is the reason why this group of steels has its characteristic 'stainlessness' or corrosion resistance. The ability of the oxide layer to heal itself means that the steel is corrosion-resistant, no matter how much of the surface is removed.

Although all stainless steels depend on the presence of chromium, other alloying elements are often added to enhance their properties. The categorisation of stainless steels is unusual amongst metals in that it is based upon the nature of the metallurgical structure. Depending on the exact chemical composition of the steel the microstructure may be made up of the stable phases austenite or ferrite, a 'duplex' mix of these two, the phase martensite created when some steels are rapidly quenched from a high temperature, or a structure hardened by precipitated micro-constituents.

Austenitic Stainless Steels

This group contains at least 16% chromium and 6% nickel (the basic grade 304 is referred to as 18/8) and range through to the high alloys or 'super austenitics' such as 904L and 6% molybdenum grades.

Additional elements can be added such as molybdenum, titanium or copper, to modify or improve stainless properties, and making them suitable for many critical applications involving high temperature as well as corrosion resistance. This group of stainless steels is also suitable for cryogenic applications because the effect of the nickel content in making the steel austenitic avoids the problems of brittleness at low temperatures, which is a characteristic of other types of steel.

The characteristics of the austenitic stainless steels are:

- Good corrosion resistance
- Weldable using standard methods and equipment
- Excellent ductility
- Stable austenite structure at all temperatures
- Cannot be hardened by heat treatment
- Harden rapidly when cold worked
- Good strength and scaling resistance at high temperatures
- Excellent cryogenic properties, and
- Non-magnetic when annealed

Ferritic Stainless Steels

These are plain chromium (10.5 to 30%) grades such as grade 430 and 409. Their moderate corrosion resistance is improved in the higher alloyed grades (such as 444) and poor fabrication properties improved in the proprietary grade AtlasCR12.

The characteristics of the ferritic grades are:

- Good resistance to corrosion, but generally not as good as the austenitics
- Not as readily welded as austenitics
- Good ductility
- Cannot be hardened by heat treatment
- Can only be moderately hardened by cold work
- Fully magnetic
- Not suitable for use at very low temperatures
- Stable ferrite structure at all temperatures, and
- Immune from chloride stress corrosion cracking

Martensitic Stainless Steels

Martensitic stainless steels are also based on the addition of chromium as the major alloying element but with a higher carbon and generally lower chromium content than the ferritic type, e.g. 12% in grades 410 and 416. Grade 431 has a chromium content of about 16% but its microstructure is still martensite despite the chromium level due to the addition of 2% nickel in the composition. The martensitic grades are used in the hardened condition for high strength applications (e.g. pump shafts) and high hardness applications (e.g. knife blades).

The characteristics of martensitic stainless steels are:

- Hardenable by heat treatment (quenching and tempering)
- Magnetic, and
- Have moderate corrosion resistance

Precipitation Hardening Stainless Steels

These are chromium and nickel containing steels, which can develop very high tensile strengths. The most common grade in this group is '17-4PH', also known as grade 630, with the composition of 17% chromium, 4% nickel, 4% copper and 0.3% niobium. The major advantage of these steels is that they can be supplied in the solution-treated condition, which is machinable. Following machining, forming, etc. the steel can be hardened by fairly low temperature 'aging' heat treatments which do not cause distortion to the component. The most common applications are shafts and spindles.

The characteristics of the precipitation hardening steels are:

- Hardenable by heat treatment (solution treatment and ageing)
- Magnetic, and
- Have moderate corrosion resistance

Duplex Stainless Steels

Duplex stainless steels such as 2205 (designation indicates 22% chromium and 5% nickel but also contains 3% molybdenum and 0.15% nitrogen) have microstructures comprising a mixture of austenite and ferrite.

Duplex austenitic-ferritic steels combine some of the characteristics of each class.

- Resistant to stress corrosion cracking, albeit not quite as resistant as ferritic grades
- Toughness is superior to ferritics but inferior to that of austenitics
- Strength is greater than that of the annealed austenitic steels by a factor of two
- Corrosion resistance is high for most grades
- They do suffer from reduced toughness below -50°C and after exposure above 300°C, so are only used between these temperatures, and
- Highly resistant to chloride stress corrosion cracking

Standard Classifications

There are many different grades of stainless steel and the American Iron and Steel Institute (AISI) in the past designated some as standard compositions, resulting in the commonly used three-digit numbering system, e.g. 304, 316, etc. This role has now been taken over by the SAE and ASTM who allocate UNS numbers to new grades. The full range of these standard stainless steel grades is contained in the Iron and Steel Society (ISS) *Steel Products Manual for Stainless Steels* and in the SAE/ASTM handbook of *Metals and Alloys in the Unified Number System*.

Although the majority of stainless steel products sold in Australia are supplied to American ASTM specifications, we see some references to European “Euronorms”. These use different grade designations, both numbers and names, but the grades are actually almost identical.

ASTM Grade	304	304L	316	316L	430	2205
UNS No.	S30400	S30403	S31600	S31603	S43000	S32205
EN No.	1.4301	1.4307	1.4401	1.4404	1.4016	1.4462
EN Name	X5CrNi18-10	X2CrNi18-9	X5CrNiMo17-12-2	X2CrNiMo17-12-2	X8Cr17	X2CrNiMoN22-5-3

Certain other grades do not have standard numbers but instead are covered by other national and international specifications for specialised products or by proprietary designations.

More complete lists of equivalent grades are given in Atlas Technical Note 3, available for download from the Atlas Steels website.

Further Product and Technical Information

Further information on stainless steels is given in the *Atlas Steels Technical Handbook of Stainless Steels*, other information across the spectrum of the Atlas portfolio is given in *Technical Notes* and *Datasheets*. These are also available for download from www.atlassteels.com.au.

Stainless Steel Sheet, Coil and Plate

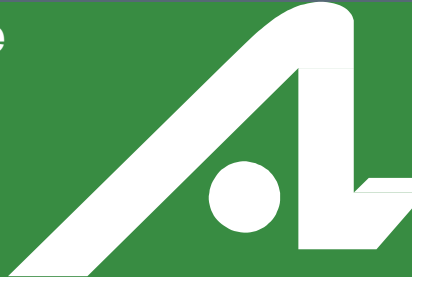

2 Stainless Steel Sheet,
Coil and Plate



2

Stainless Steel Sheet, Coil, Strip & Plate

Specifications

ASTM A240M. Chromium and chromium-nickel stainless steel plate, sheet and strip for pressure vessels and for general applications.

ASTM 480M. General requirements for flat rolled stainless and heat-resisting steel plate, sheet and strip.

The internationally recognized crossover thickness between what is referred to as sheet and plate is 5.0mm. This is specified in ASTM A480M.

Therefore, **sheet** is thickness less than 5.0mm and **plate** is 5.0mm and over.

Production

Stainless steel coil and plate consumed by the Australian market is supplied from mills throughout the world in hot rolled and cold rolled conditions.

It is common practice for large stainless steel coils to be brought into Australia and processed by a specialty metals service centre into smaller coils, sheet, strip and plate. Product over 12mm is brought into Australia as plate only.

Surface Finishes – Coil and Sheet

The following stainless steel finishes are commonly used in the Australian market.

Product	Production Process
2B	The general-purpose, cold rolled, smooth finish obtained as a result of a final light pass through polished rolls at the mill. A semi-matt finish with very good corrosion resistance.
BA	Bright Annealed finish is a bright, cold rolled, reflective finish retained by final annealing in a controlled atmosphere furnace. The finish has large application in the appliance and automotive industry and as a decorative finish in architecture. The brightness and reflectivity is a function of thickness and grade. Consultation is recommended prior to specification in architectural applications. BA finish is usually supplied with a PE or PVC coating as a surface protection.
No.4	Produced from 2B finish often by a service centre rather than the production mill. It is a general-purpose ground polished finish used widely for kitchen equipment and applications requiring a decorative finished finish. No.4 finish is usually supplied with a PE coating as a surface protection.
No.8	Highly reflective 'mirror' finish. Produced from BA finish by polishing with successive finer abrasives followed by extensive buffing. Mainly used in architectural applications.
HRAP (No 1)	Hot Rolled Annealed and Pickled finish is usual for most plate. This dull finish is also supplied on some heavier coil and AtlasCR12 coil and sheet.
Customer-specific	A service centre with polishing equipment can produce special finishes for specific applications.

Protective Coating

PI	Paper Interleave is a layer of paper intended to prevent scoring or galling between sheets or coil wraps during storage and delivery.
PE	Polyethylene coating protects the prime steel surface from handling damage during storage, transport, fabrication and installation.
LF	This is a PE film optimized to avoid bubbling and separation from the metal surface during laser cutting.
PVC	Polyvinyl Chloride film is a specialised plastic optimized for deep drawing applications.
FLV	This is a Fiber Optic Laser Film optimized to avoid bubbling & separation from the metal surface during Fiber Optic Laser Cutting.

Plastic Film Precautions

All plastic films and more particularly the adhesives that hold them to the steel have limited life. It is recommended that all plastic films be removed within three months. Exposure to sunlight (UV) should be avoided.

Stainless Steel Sheet, Coil and Strip 0.45mm to less than 5mm thick – ASTM A240M

Coil and strip					Sheet	
Grade	Thickness (mm)	Coil width (mm)	Finish	Coating Fiber Optic	Length (mm)	
					Imperial	Metric
304	0.45	914	2B	PE/LF	1829	1800
316	0.55	1219	No.4		2438	2400
	0.70	1500	BA		3048	3000
	0.90				3658	6000
304	1.20	914	2B	PE/LF		
316	1.50	1219	No.4			
	1.60	1500	BA			
	2.00					
304	2.50	914	2B	PE/LF		
316	3.00	1219	No.4			
		1500				
		2000				
304/304L	4.00	1219	2B	PE/LF		
316/316L		1500	No.1			
		2000				
430	0.70	914	2B	PE/LF		
	0.90	1219	BA			
			No.4			
Atlas3CR12	1.20	1250	No.1			
Atlas3CR12Ti	1.60	1500				
	2.00					
	3.00					
	4.00					

Other grades and widths available, but not usually ex-stock.

Grades: 301L, 301LN, 310, 321, 2205, 253MA, 444

Widths (mm): 600, 750, 900, 1050, 1200, 1524

Product outside the standard range can be indented from overseas mills or stocked by special arrangement.

Stainless Steel Coil Plate - ASTM A240M

The most efficient route for a stainless steel production mill to produce plate (5mm and over) is in coil form. The coil is then further downstream processed by the mill or through a service centre with equipment to flatten (often called 'levelling') and cut to length.

The maximum plate width produced by mills from coil is 2000mm and the maximum thickness is 13mm for hot rolled and 8mm for cold rolled.

Grade	Thickness (mm)	Coil width (mm)	Finish
304/304L	5.0	1500	2B, 2D, 2E
316/316L	6.0	2000	No.1
304/304L	8.0	1500	No.1
316/316L	10.0	2000	
	12.0		
AtlasCR12	5.0	1219	No.1
AtlasCR12Ti	6.0	1500	

Other grades available, but not always ex-stock

Grades: 310, 321, 2205, 253MA, 2507

Coil plate is commonly stocked in dual certified grade, i.e. 304/304L and 316/316L.

Stainless Steel Quarto Plate Products – ASTM A240M

Another method of producing stainless steel plate within and beyond the thickness range of coil production is from a slab of steel that is rolled in the flat condition to a specified length, width and thickness. The product of this process is commonly referred to as quarto plate and is available from mills in thickness from 5mm and above and widths to 4000mm in some thicknesses.

Grades and thickness for quarto plate are as follows:

Grades	304/304L, 316/316L, AtlasCR12, 253MA, 2205, 2507. (Indent 321, 321H etc)
Thickness (mm)	5.0, 6.0, 8.0, 10.0, 12.0, 16.0, 20.0, 25.0, 32.0, 40.0, 50.0
Width (mm)	1500, 2000, 2500
Length (mm)	6000, 7500, 8000
Finish	No.1

Non-standard grades, widths and lengths can be obtained to individual customer-specific requirements.

Quarto plate is commonly stocked as "dual certified" in the most common grades, 304/304L and 316/316L.

Stainless Steel Chequer (Floor) Plate

Grades	304
Thickness (mm)	3.18, 4.76, 6.00
Width (mm)	1219, 1250 (6mm only)
Length (mm)	2438, 3048, 2500 (6mm only)

Chequer plate pattern is typically as in the photograph below. There are minor differences in tread pattern depending on the manufacturing mill.



Processing for Plate

Atlas Steels Services Centres can also arrange processing such as:

- Plasma cutting
- Laser cutting
- Water jet cutting
- Bending or folding
- Polishing
- Plastic coating

Please contact your sales representative for individual State processing capabilities and service parameters.

Stainless Steel Pipe, Fittings & Flanges



3 Stainless Steel Pipe, Fittings & Flanges



3

A stainless steel pipe system is the product of choice for carrying corrosive or sanitary fluids, slurries and gases, particularly where high pressures, high temperatures or corrosive environments are involved. Due to stainless steel's aesthetic properties, stainless steel pipe is also used in architectural applications.

Stainless steel pipe can be generally defined as a heavy wall thickness tubing, with dimensions as specified by the American National Standards Institute (ANSI). Pipe dimensions are specified by outside diameter – indicated by the NPS (imperial) or DN (metric) designator and sometimes confusingly referred to as the 'nominal bore' – and wall thickness, reflected in the schedule number. ASME B36.19M covers these dimensions.

Stainless steel pipe and fittings are supplied in the annealed condition to facilitate fabrication and ensure best corrosion resistance. Atlas Steels can also supply stainless steel pipe with an abrasive polished external finish suitable for architectural applications.

Welded Pipe

Welded stainless steel pipe is manufactured from 2B or HRAP stainless steel strip – formed to shape, longitudinally welded and annealed.

Large size pipe is fabricated from plate.

All welds are made without the addition of filler metal, except for very large diameters.

Standard welded pipe is in nominal lengths of 6.0 or 6.1 metres.

Manufacturing specification: ASTM A312M – Austenitic
ASTM A358M – Austenitic (large diameter)
ASTM A790M – Duplex

Seamless Pipe

Seamless stainless steel pipe is produced from hollow billets, which are pierced then usually cold drawn until they reach the final desired pipe size, then annealed.

Standard seamless pipe is supplied in nominal lengths of 6.1 metres to DN 150 (NPS 6) and above this in random lengths.

Manufacturing specification: ASTM A312M – Austenitic
ASTM A790M – Duplex

Stainless steel piping systems can be joined by butt welding and, in the heavier 40S and 80S schedules, by threaded connections.

The complete piping system is made possible using complementary fittings and flanges. These are specified by the same DN or NPS designator and schedule numbering system as for pipe.

Butt Welding Pipe Fittings

A piping system using butt welding fittings has many inherent advantages over other forms.

- Welding a fitting to the pipe means that it is permanently leak proof
- The continuous metal structure formed between pipe and fitting adds strength to the system
- Smooth inner surface and gradual direction changes reduce pressure losses and turbulence and minimise the action of corrosion and erosion
- A welded system utilizes a minimum of space

Atlas Steels Supply Butt Welding Fittings in the following forms

- Elbows 45° and 90° – long radius is standard; short radius is also available
- Return bends 180° – long radius is standard; short radius is also available
- Reducers – concentric and eccentric
- Tees – equal and reducing
- Caps
- Stub ends – Type B, to MSS SP-43

Butt welding fittings can be supplied in either seamless or welded construction and are covered by specification ASTM A403M (or ASTM A815M for Duplex grades) and ASME B16.9.

Screwed and Socket Weld Fittings

Piping systems can be connected using screwed fittings – BSP threaded (“150lb”) low pressure fittings and NPT threaded (class 3000) high pressure fittings in Grade 316.

Socket weld fittings are used in high pressure piping systems and are available in grade 316L to suit schedule 80S wall thickness piping.

Manufacturing specification: ASTM A182M (Class 3000 NPT and socket weld) and
ASME B16.11
ISO 4144 (BSP dimensions)

Pipe Flanges

A flange is a ring of steel (forged, cut from plate, or rolled) designed to connect sections of pipe, or to join pipe to a pressure vessel, valve, pump or other integral flanged assembly.

Flanges are joined to each other by bolting, and are joined to the piping system by welding or threading (or loose when stub ends are used).

The basic types of flanges are:

- Slip-on
- Blind
- Weld neck
- Threaded
- Socket weld
- Lap joint
- Orifice

Forged stainless steel flanges are designed to the following common pressure ratings: Classes 150, 300, 600, 900, 1500 and 2500. Standard sealing face is Raised Face (RF).

Manufacturing specification: ASTM A182M and ASME B16.5.
(Flanges over NPS24/DN 600 to ASME B16.47, API 60S or BS 3293)

Plate stainless steel flanges are forged or cut and machined from plate – Table 'D', Table 'E', etc.

Manufacturing specification: AS2129

Waterworks flanges to AS4087 and PN16 flanges to EN 1092-1 are also available subject to enquiry.

Types and Applications of Flanges

Slip-on flanges – the flange is slipped over the pipe and then welded both inside and outside to provide sufficient strength and prevent leakage. Slip-on flanges are also used as loose back-up flanges when Type B stub ends are used.

Blind flanges – this is a flange without a centre bore, used to shut off a piping system or vessel opening.

Weld neck flanges – designed to be joined to a piping system by butt welding. They are relatively expensive due to the weld neck, but are preferred for high-stress applications.

Lap joint flanges – this is again similar to a slip-on flange, but has a radius at the intersection of the centre bore and the flange face to accommodate a Type A lap joint stub end. Lap joint flanges and Type A stub ends are not commonly stocked in Australia.

Stainless Steel Pipe – Welded & Seamless – ASTM A312M / ASTM A790M

Grades: 304/304L, 316/316L, 2205

Stainless steel pipe is available in a wide range of sizes in welded and seamless construction, ex-stock or on indent.

Nominal Pipe Size		Outside Diameter (mm)	Wall Thickness (mm)							
			Sch 5S		Sch 10S		Sch 40S		Sch 80S	
DN	NPS		WT (mm)	Weight (kg/m)	WT (mm)	Weight (kg/m)	WT (mm)	Weight (kg/m)	WT (mm)	Weight (kg/m)
6	1/8	10.3			1.24	0.28	1.73	0.37	2.41	0.47
8	1/4	13.7			1.65	0.49	2.24	0.63	3.02	0.80
10	3/8	17.1			1.65	0.63	2.31	0.84	3.20	1.10
15	1/2	21.3	1.65	0.80	2.11	1.00	2.77	1.27	3.73	1.62
20	3/4	26.7	1.65	1.02	2.11	1.28	2.87	1.69	3.91	2.20
25	1	33.4	1.65	1.29	2.77	2.09	3.38	2.50	4.55	3.24
32	1 1/4	42.2	1.65	1.65	2.77	2.69	3.56	3.39	4.85	4.47
40	1 1/2	48.3	1.65	1.90	2.77	3.11	3.68	4.05	5.08	5.41
50	2	60.3	1.65	2.39	2.77	3.93	3.91	5.44	5.54	7.48
65	2 1/2	73.0	2.11	3.69	3.05	5.26	5.16	8.63	7.01	11.41
80	3	88.9	2.11	4.52	3.05	6.46	5.49	11.29	7.62	15.27
90	3 1/2	101.6	2.11	5.18	3.05	7.41	5.74	13.57	8.08	18.64
100	4	114.3	2.11	5.84	3.05	8.37	6.02	16.08	8.56	22.32
125	5	141.3	2.77	9.46	3.40	11.56	6.55	21.77	9.53	30.97
150	6	168.3	2.77	11.31	3.40	13.83	7.11	28.26	10.97	42.56
200	8	219.1	2.77	14.78	3.76	19.97	8.18	42.55	12.70	64.64
250	10	273.1	3.40	22.61	4.19	27.79	9.27	60.31	12.70	81.56
300	12	323.9	3.96	31.25	4.57	35.99	9.53	73.88	12.70	97.47
350	14	355.6	3.96	34.34	4.78	41.36	9.53	81.33	12.70	107.40
400	16	406.4	4.19	41.56	4.78	47.34	9.53	93.27	12.70	123.31
450	18	457	4.19	46.79	4.78	53.31	9.53	105.17	12.70	139.16
500	20	508	4.78	59.32	5.54	68.65	9.53	117.15	12.70	155.13
550	22	559	4.78	65.33	5.54	75.62				
600	24	610	5.54	82.58	6.35	94.53	9.53	141.12	12.70	187.07
650	26	660								
700	28	711								
750	30	762	6.35	118.34	7.92	147.29				

- Stainless steel pipe nominal dimensions listed in the table are based on ASTM A312M and ASME B36.19M.
- These dimensions are nominal – substantial tolerances apply – refer to Atlas Steels *TechNote 12* and the ASTM and ASME standards for details.
- For other wall thicknesses and larger sizes consult ASME B36.10M; stainless steel pipe may be available to these carbon steel pipe sizes.

Welded Butt Welding Fittings – ASTM A403M & ASME B16.9



Product range and theoretical weights (kg)										
DN	Schedule 10S					Schedule 40S				
	90° Elbow	45° Elbow	Equal tee	Stub end type B	End cap	90° Elbow	45° Elbow	Equal tee	Stub end type B	End cap
15	0.06	0.03	0.09	0.07	0.03	0.08	0.04	0.10	0.08	0.04
20	0.07	0.03	0.13	0.09	0.05	0.08	0.04	0.17	0.11	0.07
25	0.14	0.08	0.28	0.16	0.08	0.15	0.11	0.29	0.17	0.10
32	0.23	0.11	0.49	0.22	0.10	0.26	0.17	0.59	0.25	0.18
40	0.30	0.17	0.68	0.25	0.11	0.40	0.23	0.86	0.31	0.20
50	0.50	0.25	0.85	0.43	0.13	0.70	0.40	1.28	0.61	0.23
65	0.85	0.48	1.41	0.57	0.19	1.40	0.77	2.19	0.80	0.27
80	1.25	0.63	1.77	0.72	0.25	2.20	1.08	3.31	1.13	0.42
100	2.10	1.08	3.46	1.09	0.68	4.47	1.47	5.27	1.87	1.14
125	3.65	1.82	5.44	1.47	1.11	6.80	2.84	9.63	2.79	2.13
150	5.45	2.72	8.03	2.15	1.42	10.89	5.44	10.99	3.57	3.23
200	10.20	5.33	15.65	3.22	2.38	21.54	10.77	20.91	6.07	5.19
250	18.15	9.75	26.76	5.13	4.45	38.56	19.27	35.38	10.07	9.00
300	25.80	13.62	39.46	8.16	7.50	59.42	29.71	62.14	14.29	15.00
350	36.29	18.37	48.53	10.88	8.17	79.38	35.15	79.31	17.14	16.00
400	47.63	23.81	58.97	12.70	10.67	99.79	45.81	99.79	20.41	21.00
450	59.87	29.94	79.65	17.23	13.00	129.73	59.40	129.73	27.21	26.00
500	99.80	49.90	103.42	21.77	17.00	162.38	74.84	162.39	29.94	34.00
600	140.61	70.31	155.58	27.21	26.00	225.89	105.23	225.90	38.55	52.00

Grades: Butt welding fittings are usually supplied as dual certified 304/304L or 316/316L

Welded Butt Welding Fittings – ASTM A403M & ASME B16.9



Product range and theoretical weights (kg)						
DN	Schedule 10S			Schedule 40S		
	Con reducer	Ecc reducer	Reducing tee	Con reducer	Ecc reducer	Reducing tee
20x15	0.10	0.10	0.11	0.14	0.14	0.15
25x15	0.12	0.12	0.25	0.15	0.15	0.26
25x20	0.13	0.13	0.25	0.16	0.16	0.27
32x20	0.18	0.18	0.44	0.22	0.22	0.52
32x25	0.18	0.18	0.45	0.22	0.22	0.53
40x20	0.18	0.18	0.58	0.24	0.24	0.74
40x25	0.19	0.19	0.60	0.26	0.26	0.76
40x32	0.21	0.24	0.61	0.28	0.28	0.77
50x25	0.28	0.28	0.73	0.40	0.40	1.10
50x32	0.30	0.30	0.74	0.44	0.44	1.13
50x40	0.31	0.31	0.76	0.45	0.45	1.15
65x40	0.44	0.44	1.24	0.76	0.76	1.94
65x50	0.47	0.47	1.25	0.80	0.80	1.98
80x40	0.51	0.51	1.52	0.94	0.94	2.85
80x50	0.55	0.55	1.56	1.00	1.00	2.91
80x65	0.59	0.59	1.59	1.08	1.08	2.98
100x40	0.68	0.68	2.90	1.36	1.36	4.53
100x50	0.78	0.78	2.94	1.57	1.57	4.48
100x65	0.83	0.83	2.97	1.66	1.66	4.54
100x80	0.87	0.87	3.04	1.74	1.74	4.64
125x100	1.49	1.49	5.49	2.98	2.98	8.47
150x80	1.82	1.82	6.86	3.98	3.98	11.94
150x100	1.96	1.96	7.10	4.07	4.07	9.68
150x125	2.00	2.00	7.27	4.07	4.07	9.99
200x100	3.01	3.01	13.46	6.55	6.55	17.98
200x150	3.19	3.19	14.08	6.94	6.94	18.82
250x100	4.73	4.73	22.75	10.52	10.52	30.07
250x150	5.00	5.00	23.55	11.12	11.12	31.13
250x200	5.20	5.20	24.08	11.56	11.56	31.84
300x200	7.67	7.67	34.73	15.98	15.98	54.43
300x250	7.98	7.98	35.52	16.63	16.63	55.79
350x300	15.29	15.29	43.96	30.58	30.58	71.21
400x200	16.70	16.70	49.90	33.40	33.40	84.82
400x250	17.22	17.22	50.80	35.43	35.43	85.73
400x300	18.35	18.35	51.71	36.70	36.70	87.54

Grades: Butt Welding Fittings are usually supplied as dual certified 304/304L or 316/316L

Seamless Butt Welding Fittings – ASTM A403M & ASME B16.9

Product range and theoretical weights (kg)									
DN	Schedule 10S			Schedule 40S			Schedule 80S		
	90° Elbow	45° Elbow	Equal tee	90° Elbow	45° Elbow	Equal tee	90° Elbow	45° Elbow	Equal tee
8	0.02	0.01	0.03	0.03	0.02	0.06	0.04	0.03	0.07
10	0.03	0.02	0.05	0.03	0.02	0.03	0.06	0.04	0.09
15	0.06	0.03	0.09	0.08	0.04	0.10	0.10	0.05	0.14
20	0.07	0.03	0.13	0.08	0.04	0.17	0.11	0.05	0.20
25	0.14	0.08	0.28	0.15	0.11	0.29	0.22	0.14	0.38
32	0.23	0.11	0.49	0.26	0.17	0.59	0.40	0.23	0.68
40	0.30	0.17	0.68	0.40	0.23	0.86	0.51	0.29	1.02
50	0.50	0.25	0.85	0.70	0.4	1.28	0.91	0.59	1.59
65	0.85	0.48	1.41	1.40	0.77	2.19	1.81	0.99	3.13
80	1.25	0.63	1.77	2.20	1.08	3.31	2.97	1.50	4.45
90	1.70	0.75	2.67	2.83	1.42	4.08	4.00	2.00	5.44
100	2.10	1.08	3.46	4.47	2.09	5.27	6.18	2.81	7.71
150	5.45	2.72	8.07	10.89	5.44	10.99	16.32	8.16	13.61
200	10.20	5.33	15.65	21.54	10.77	20.91	33.11	16.56	28.12
250	18.15	9.75	26.46	38.56	19.27	35.38	51.71	25.86	49.90
300	25.80	13.62	39.46	59.42	29.71	62.14	79.38	39.69	83.91

Seamless Butt Welding Fittings – ASTM A403 & ASME B16.9

Product range and theoretical weights (kg)									
DN	Schedule 10S			Schedule 40S			Schedule 80S		
	Con reducer	Ecc reducer	Reducing tee	Con reducer	Ecc reducer	Reducing tee	Con reducer	Ecc reducer	Reducing tee
40x.25	0.19	0.19	0.60	0.26	0.26	0.76	0.34	0.34	0.90
50x25	0.28	0.28	0.73	0.40	0.40	1.10	0.54	0.54	1.37
50x40	0.31	0.31	0.76	0.45	0.45	1.15	0.59	0.59	1.43
80x.50	0.55	0.55	1.56	1.00	1.00	2.91	1.79	1.79	3.91
100x50	0.78	0.78	2.94	1.50	1.50	4.48	1.95	1.95	6.55
100x80	0.87	0.87	3.04	1.74	1.74	4.64	2.33	2.33	6.79
150x80	1.82	1.82	6.86	3.95	3.95	9.68	5.51	5.51	11.57
150x100	1.96	1.96	7.10	4.07	4.07	11.94	5.96	5.96	11.97
200x100	3.01	3.01	13.46	6.55	6.55	17.98	9.23	9.23	24.18
200x150	3.19	3.19	14.08	6.74	6.74	18.82	10.12	10.12	25.31

- Austenitic grades specified to ASTM A403M
- Duplex grades specified to ASTM A815M
- Buttwelding fittings are usually supplied as dual certified 304/304L or 316/316L
- Duplex grades 2205 and 2507 are also available in certain sizes.

Stainless Steel Butt Welding Fittings – Dimensions

Butt Welding Fittings to ASME B16.9															
Nominal size		OD	Elbows			Returns				Caps	Reducers Note 1	Stub Ends			
			Long		Short	Long		Short				Long	Short	Radius of Fillet	Diam of Lap
			90 deg	45 deg	90 deg	O	K	O	K						
DN	NPS	D	A	B	A	O	K	O	K	E	H	F	F	R	G
15	½	21.3	38	16		76	48			25		76	51	3	35
20	¾	26.7	38	19		76	51			25	38	76	51	3	43
25	1	33.4	38	22	25	76	56	51	41	38	51	102	51	3	51
32	1¼	42.2	48	25	32	95	70	64	52	38	51	102	51	5	64
40	1½	48.3	57	29	38	114	83	76	62	38	64	102	51	6	73
50	2	60.3	76	35	51	152	106	102	81	38	76	152	64	8	92
65	2½	73.0	95	44	64	190	132	127	100	38	89	152	64	8	106
80	3	88.9	114	51	76	229	159	152	121	51	89	152	64	10	127
90	3½	101.6	133	57	89	267	184	178	140	64	102	152	76	10	140
100	4	114.3	152	64	102	305	210	203	159	64	102	152	76	11	157
125	5	141.3	190	79	127	381	262	254	197	76	127	203	76	11	185
150	6	168.3	229	95	152	457	313	305	237	89	140	203	89	13	218
200	8	219.1	305	127	203	610	414	406	313	102	152	203	102	13	270
250	10	273.0	381	159	254	762	518	508	391	127	178	254	127	13	324
300	12	323.8	457	190	305	914	619	610	467	152	203	254	152	13	381
350	14	355.6	533	222	356	1067	711	711	533	165	330	305	152	13	413
400	16	406.4	610	254	406	1219	813	813	610	178	356	305	152	13	470
450	18	457	686	286	457	1372	914	914	686	203	381	305	152	13	533
500	20	508	762	318	508	1524	1016	1016	762	229	508	305	152	13	584
550	22	559	838	343	559	1676	1118	1118	838	254	508	305	152	13	641
600	24	610	914	381	610	1829	1219	1219	914	267	508	305	152	13	692
650	26	660	991	405						267	610				
700	28	711	1067	438						267	610				
750	30	762	1143	470						267	610				
800	32	813	1219	502						267	610				
850	34	864	1295	533						267	610				
900	36	914	1372	565						267	610				
950	38	965	1448	600						305	610				
1000	40	1016	1524	632						305	610				
1050	42	1067	1600	660						305	610				
1100	44	1118	1676	695						343	610				
1150	46	1168	1753	727						343	711				
1200	48	1219	1829	759						343	711				

Note 1: Reducer dimension "H" is based on large end nominal size.

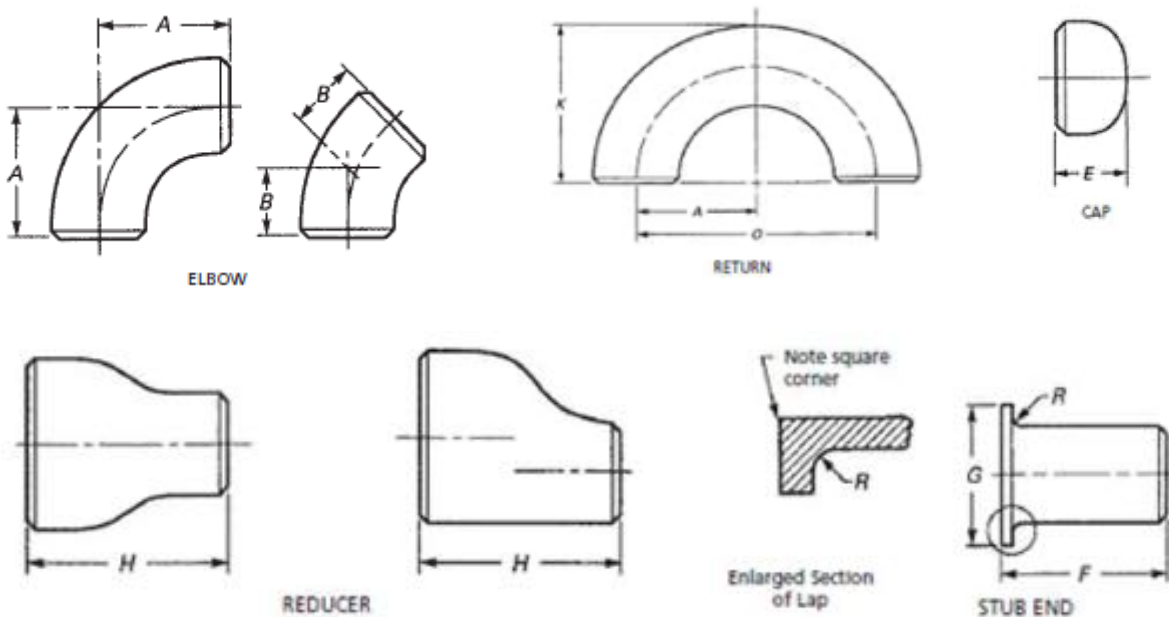

Stainless Steel ASME/ANSI Flanges – Dimensions & Weights

These diagrams relate to the tables of flange specified dimensions on the following pages.

The Notes shown on this page also relate to the tables on the following pages.

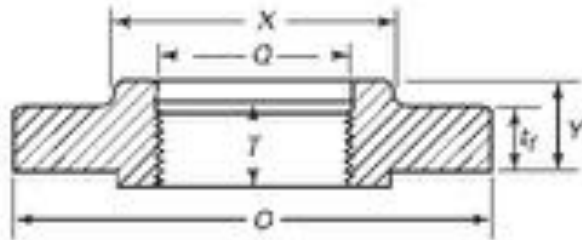

Threaded

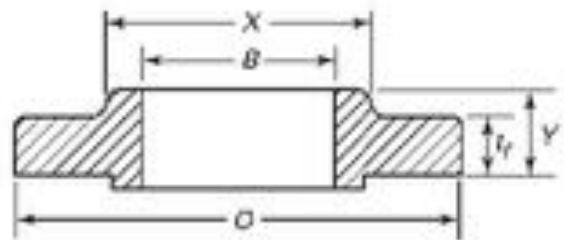

Slip-On Welding

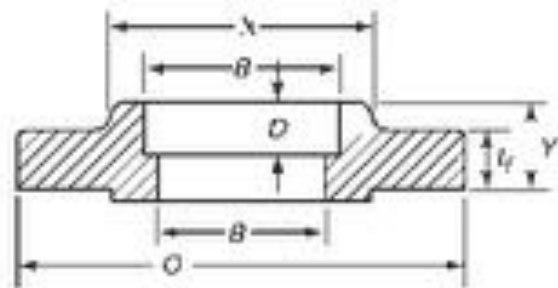

Socket Welding

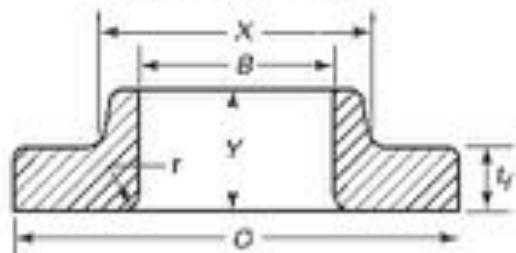

Lapped

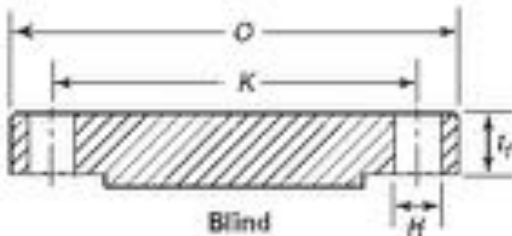

Blind

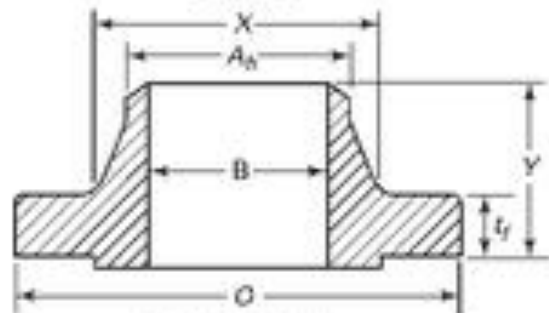

Welding Neck

Note 1: To be specified by purchase

Note 2: Flange weights are approximate

Note 3: Welding neck flange bore sizes listed are for sch 40S / Standard Wall pipe

Common stock items are –

- Slip-On Welding
- Welding Neck
- Blind

Stainless Steel ASME/ANSI Flanges – Dimensions & Weights

Class 150 Flanges to ASME B16.5																	
Nominal Size		Dimensions													Flange Weight (kg)		
DN	NPS	Flange OD (mm) O	Thick-ness min (mm) t _f	Hub Diam. (mm) X	Hub Diam. Welding Neck (mm) A _n	Length Thru Hub		Bore		Bolt Drilling					Slip-on	Welding Neck	Blind
						Slip-on/Socket Welding (mm) Y	Welding Neck (mm) Y	Slip-on/Socket Welding min (mm) B	Welding Neck / Socket Welding (mm) B	Circle Diam. (mm) K	Hole Diam. (mm) H	Bolts (No.)	RF Stud Bolt Length (mm)	RF Machine Bolt Length (mm)			
15	½	90	9.6	30	21.3	14	46	22.2	15.8	60.3	15.9	4	55	50	0.4	0.5	0.4
20	¾	100	11.2	38	26.7	14	51	27.7	20.9	69.9	15.9	4	65	50	0.6	0.7	0.6
25	1	110	12.7	49	33.4	16	54	34.5	26.6	79.4	15.9	4	65	55	0.8	1.0	0.9
32	1 ¼	115	14.3	59	42.2	19	56	43.2	35.1	88.9	15.9	4	70	55	1.0	1.3	1.2
40	1 ½	125	15.9	65	48.3	21	60	49.5	40.9	98.4	15.9	4	70	65	1.3	1.7	1.5
50	2	150	17.5	78	60.3	24	62	61.9	52.5	120.7	19.1	4	85	70	2.1	2.6	2.4
65	2 ½	180	20.7	90	73.0	27	68	76.6	62.7	139.7	19.1	4	90	75	3.3	4.1	3.9
80	3	190	22.3	108	88.9	29	68	90.7	77.9	152.4	19.1	4	90	75	3.9	4.9	4.9
90	3 ½	215	22.3	122	101.6	30	70	103.4	90.1	177.8	19.1	8	90	75	4.8	6.1	6.2
100	4	230	22.3	135	114.3	32	75	116.1	102.3	190.5	19.1	8	90	75	5.3	6.8	7.0
125	5	255	22.3	164	141.3	35	87	143.8	128.2	215.9	22.2	8	95	85	6.1	8.6	8.5
100	4	230	22.3	135	114.3	32	75	116.1	102.3	190.5	19.1	8	90	75	5.3	6.8	7.0
125	5	255	22.3	164	141.3	35	87	143.8	128.2	215.9	22.2	8	95	85	6.1	8.6	8.6
150	6	280	23.9	192	168.3	38	87	170.7	154.1	241.3	22.2	8	100	85	7.5	11	11
200	8	345	27.0	246	219.1	43	100	221.5	202.7	298.5	22.2	8	110	90	12	18	20
250	10	405	28.6	305	273.0	48	100	276.2	254.6	362.0	25.4	12	115	100	17	24	29
300	12	485	30.2	365	323.8	54	113	327.0	304.8	431.8	25.4	12	120	100	26	37	43
350	14	535	33.4	400	355.6	56	125	359.2	Note (1)	476.3	28.6	12	135	115	35	48	58
400	16	595	35.0	457	406.4	62	125	410.5	Note (1)	539.8	28.6	16	135	115	45	61	76
450	18	635	38.1	505	457.0	67	138	461.8	Note (1)	577.9	31.8	16	145	125	49	68	94
500	20	700	41.3	559	508.0	71	143	513.1	Note (1)	635.0	31.8	20	160	140	62	85	122
600	24	815	46.1	663	610.0	81	151	616.0	Note (1)	749.3	34.9	20	170	150	87	115	186

Class 300 Flanges to ASME B16.5																	
Nominal Size		Dimensions													Flange Weight (kg)		
DN	NPS	Flange OD (mm) O	Thick-ness min (mm) t _f	Hub Diam. (mm) X	Hub Diam. Welding Neck (mm) A _n	Length Thru Hub		Bore		Bolt Drilling					Slip-on	Welding Neck	Blind
						Slip-on/Socket Welding (mm) Y	Welding Neck (mm) Y	Slip-on/Socket Welding min (mm) B	Welding Neck / Socket Welding (mm) B	Circle Diam. (mm) K	Hole Diam. (mm) H	Bolts (No.)	RF Stud Bolt Length (mm)	RF Machine Bolt Length (mm)			
15	½	95	12.7	38	21.3	21	51	22.2	15.8	66.7	15.9	4	65	55	0.6	0.8	0.6
20	¾	115	14.3	48	26.7	24	56	27.7	20.9	82.6	19.1	4	75	65	1.2	1.3	1.2
25	1	125	15.9	54	33.4	25	60	34.5	26.6	88.9	19.1	4	75	65	1.4	1.6	1.4
32	1 ¼	135	17.5	64	42.2	25	64	43.2	35.1	98.4	19.1	4	85	70	1.7	2.1	1.8
40	1 ½	155	19.1	70	48.3	29	67	49.5	40.9	114.3	22.2	4	90	75	2.6	3.1	2.7
50	2	165	20.7	84	60.3	32	68	61.9	52.5	127.0	19.1	8	90	75	2.9	3.4	3.1
65	2 ½	190	23.9	100	73.0	37	75	74.6	62.7	149.2	22.2	8	100	85	4.5	5.3	4.8
80	3	210	27.0	117	88.9	41	78	90.7	77.9	168.3	22.2	8	110	90	6.2	7.3	6.8
90	3 ½	230	28.6	133	101.6	43	79	103.4	90.1	184.2	22.2	8	110	95		8.2	9.5
100	4	255	30.2	146	114.3	46	84	116.1	102.3	200.0	22.2	8	115	95		11	12
125	5	280	33.4	178	141.3	49	97	143.8	128.2	235.0	22.2	8	120	110		15	16
150	6	320	35.0	206	168.3	51	97	170.7	154.1	269.9	22.2	12	120	110		20	21
200	8	380	39.7	260	219.1	60	110	221.5	202.7	330.2	25.4	12	140	120		30	35
250	10	445	46.1	321	273.0	65	116	276.2	254.6	387.4	28.6	16	160	140		44	55
300	12	520	49.3	375	323.8	71	129	327.0	304.8	450.8	31.8	16	170	145		64	79
350	14	585	52.4	425	355.6	75	141	359.2	Note (1)	514.4	31.8	20	180	160		88	107
400	16	650	55.6	483	406.4	81	144	410.5	Note (1)	571.5	34.9	20	190	165		113	139
450	18	710	58.8	533	457.0	87	157	461.8	Note (1)	628.6	34.9	24	195	170		138	177
500	20	775	62.0	587	508.0	94	160	513.1	Note (1)	685.8	34.9	24	205	185		167	223
600	24	915	68.3	702	610.0	105	167	616.0	Note (1)	812.8	41.3	24	230	205		235	342

These flanges are available in a very wide range of sizes, ratings and types in 304/304L and 316/316L. Other grades such as 2205 are available subject to enquiry.

Stainless Steel ASME/ANSI Flanges – Dimensions & Weights

Class 600 Flanges to ASME B16.5																
Nominal Size		Dimensions												Flange Weight (kg)		
DN	NPS	Flange OD (mm) O	Thick-ness min (mm) t _f	Hub Diam. (mm) X	Hub Diam. Welding Neck (mm) A _h	Length Thru Hub		Bore		Bolt Drilling				Slip-on	Welding Neck	Blind
						Slip-on/Socket Welding (mm) Y	Welding Neck (mm) Y	Slip-on/Socket Welding min (mm) B	Welding Neck / Socket Welding (mm) B	Circle Diam. (mm) K	Hole Diam. (mm) H	Bolts (No.)	RF Stud Bolt Length (mm)			
15	½	95	14.3	38	21.3	22	52	22.2	Note (1)	66.7	15.9	4	75	0.9	0.9	0.9
20	¾	115	15.9	48	26.7	25	57	27.7	Note (1)	82.6	19.1	4	90	1.4	1.6	1.4
25	1	125	17.5	54	33.4	27	62	34.5	Note (1)	88.9	19.1	4	90	1.8	1.9	1.8
32	1 ¼	135	20.7	64	42.2	29	67	43.2	Note (1)	98.4	19.1	4	95	2.6	2.5	2.4
40	1 ½	155	22.3	70	48.3	32	70	49.5	Note (1)	114.3	22.2	4	110	3.2	3.6	3.4
50	2	165	25.4	84	60.3	37	73	61.9	Note (1)	127.0	19.1	8	110	3.9	4.5	4.4
65	2 ½	190	28.6	100	73.0	41	79	74.6	Note (1)	149.2	22.2	8	120	5.9	6.4	6.8
80	3	210	31.8	117	88.9	46	83	90.7	Note (1)	168.3	22.2	8	125	7.4	8.1	8.9
90	3 ½	230	35.0	133	101.6	49	86	103.4	Note (1)	184.	25.4	8	140		12	13
100	4	275	38.1	152	114.3	54	102	116.1	Note (1)	215.9	25.4	8	145		17	19
125	5	330	44.5	189	141.3	60	114	143.8	Note (1)	266.7	28.6	8	165		31	31
150	6	355	47.7	222	168.3	67	117	170.7	Note (1)	292.1	28.6	12	170		37	38
200	8	420	55.6	273	219.1	76	133	221.5	Note (1)	349.2	31.8	12	190		51	62
250	10	510	63.5	343	273.0	86	152	276.2	Note (1)	431.8	34.9	16	215		86	102
300	12	560	66.7	400	323.8	92	156	327.0	Note (1)	489.0	34.9	20	220		103	132
350	14	605	69.9	432	355.6	94	165	359.2	Note (1)	527.0	38.1	20	235		122	158
400	16	685	76.2	495	406.4	106	178	410.5	Note (1)	603.2	41.3	20	255		177	225
450	18	745	82.6	546	457.0	117	184	461.8	Note (1)	654.0	44.5	20	275		216	285
500	20	815	88.9	610	508.0	127	190	513.1	Note (1)	723.9	44.5	24	285		268	365
600	24	940	101.6	718	610.0	140	203	616.0	Note (1)	838.2	50.8	24	330		372	533

Class 900 Flanges to ASME B16.5																
Nominal Size		Dimensions												Flange Weight (kg)		
DN	NPS	Flange OD (mm) O	Thick-ness min (mm) t _f	Hub Diam. (mm) X	Hub Diam. Welding Neck (mm) A _h	Length Thru Hub		Bore		Bolt Drilling				Slip-on	Welding Neck	Blind
						Slip-on/Socket Welding (mm) Y	Welding Neck (mm) Y	Slip-on/Socket Welding min (mm) B	Welding Neck / Socket Welding (mm) B	Circle Diam. (mm) K	Hole Diam. (mm) H	Bolts (No.)	RF Stud Bolt Length (mm)			
15	½	120	22.3	38	21.3	32	60	22.2	Note (1)	82.6	22.2	4	110	1.8	2.1	1.9
20	¾	130	25.4	44	26.7	35	70	27.7	Note (1)	88.9	22.2	4	115	2.3	2.7	2.7
25	1	150	28.6	52	33.4	41	73	34.5	Note (1)	101.6	25.4	4	125	3.4	3.9	4.1
32	1 ¼	160	28.6	64	42.2	41	73	43.2	Note (1)	111.1	25.4	4	125	4.1	4.5	4.3
40	1 ½	180	31.8	70	48.3	44	83	49.5	Note (1)	123.8	28.6	4	140	5.5	5.9	5.9
50	2	215	38.1	105	60.3	57	102	61.9	Note (1)	165.1	25.4	8	145	11	11	11
65	2 ½	245	41.3	124	73.0	64	105	74.6	Note (1)	190.5	28.6	8	160	16	16	16
80	3	240	38.1	127	88.9	54	102	90.7	Note (1)	190.5	25.4	8	145	12	15	13
100	4	290	44.5	159	114.3	70	114	116.1	Note (1)	235.0	31.8	8	170	23	23	25
125	5	350	50.8	190	141.3	79	127	143.8	Note (1)	279.4	34.9	8	190	38	39	39
150	6	380	55.6	235	168.3	86	140	170.7	Note (1)	317.5	31.8	12	190	48	50	52
200	8	470	63.5	298	219.1	102	162	221.5	Note (1)	393.7	38.1	12	220	75	79	59
250	10	545	39.9	368	273.0	108	184	276.2	Note (1)	469.9	38.1	16	235	111	118	132
300	12	610	79.4	419	323.8	117	200	327.0	Note (1)	533.4	38.1	20	255	146	157	187
350	14	640	85.8	451	355.6	130	213	359.2	Note (1)	558.8	41.3	20	275	172	182	224
400	16	705	88.9	508	406.4	133	216	410.5	Note (1)	616.0	44.5	20	285	193	225	272
450	18	785	101.6	565	457.0	152	229	461.8	Note (1)	685.8	50.8	20	325	272	309	386
500	20	855	108.0	622	508.0	159	248	513.1	Note (1)	749.3	54.0	20	350	331	377	488
600	24	1040	139.7	749	610.0	203	292	616.0	Note (1)	901.7	66.7	20	440	632	685	905

These flanges are available in a very wide range of sizes, ratings and types in 304/304L and 316/316L. Other grades such as 2205 are available subject to enquiry.

Stainless Steel ASME/ANSI Flanges – Dimensions & Weights

Class 1500 Flanges to ASME B16.5																
Nominal Size		Dimensions												Flange Weight (kg)		
DN	NPS	Flange OD (mm) O	Thick-ness min (mm) t_r	Hub Diam. (mm) X	Hub Diam. Welding Neck (mm) A_h	Length Thru Hub		Bore		Bolt Drilling				Slip-on	Welding Neck	Blind
						Slip-on/Socket Welding (mm) Y	Welding Neck (mm) Y	Slip-on/Socket Welding min (mm) B	Welding Neck / Socket Welding (mm) B	Circle Diam. (mm) K	Hole Diam. (mm) H	Bolts (No.)	RF Stud Bolt Length (mm)			
15	½	120	22.3	38	21.3	32	60	22.2	Note (1)	82.6	22.2	4	110	1.8	2.1	1.9
20	¾	130	25.4	44	26.7	35	70	27.7	Note (1)	88.9	22.2	4	115	2.8	2.7	2.7
25	1	150	28.6	52	33.4	41	73	34.5	Note (1)	101.6	25.4	4	125	3.6	3.9	4.1
32	1 ¼	160	28.6	64	42.2	41	73	43.2	Note (1)	111.1	25.4	4	125	5.0	4.5	4.3
40	1 ½	180	31.8	70	48.3	44	83	49.5	Note (1)	123.8	28.6	4	140	6.8	5.9	5.9
50	2	215	38.1	105	60.3	57	102	61.9	Note (1)	165.1	25.4	8	145	11	11	11
65	2 ½	245	41.3	124	73.0	64	105	74.6	Note (1)	190.5	28.6	8	160	16	16	16
80	3	265	47.7	133	88.9		117		Note (1)	203.2	31.8	8	180		22	22
100	4	310	54.0	162	114.3		124		Note (1)	241.3	34.9	8	195		31	33
125	5	375	73.1	197	141.3		156		Note (1)	292.1	41.3	8	250		59	60
150	6	395	82.6	229	168.3		171		Note (1)	317.5	38.1	12	260		75	75
200	8	485	92.1	292	219.1		213		Note (1)	393.7	44.5	12	290		124	137
250	10	585	108.0	368	273.0		254		Note (1)	482.6	50.8	12	335		206	230
300	12	675	123.9	451	323.8		283		Note (1)	571.5	54.0	16	375		306	316
350	14	750	133.4	495	355.6		298		Note (1)	635.0	60.3	16	405		416	421
400	16	825	146.1	552	406.4		311		Note (1)	704.8	66.7	16	445		568	559
450	18	915	162.0	597	457.0		327		Note (1)	774.7	73.0	16	495		736	761
500	20	985	177.8	641	508.0		356		Note (1)	831.8	79.4	16	540		929	967
600	24	1170	203.2	762	610.0		406		Note (1)	990.6	92.1	16	615		1504	1568

Class 2500 Flanges to ASME B16.5																
Nominal Size		Dimensions												Flange Weight (kg)		
DN	NPS	Flange OD (mm) O	Thick-ness min (mm) t_r	Hub Diam. (mm) X	Hub Diam. Welding Neck (mm) A_h	Length Thru Hub		Bore		Bolt Drilling				Slip-on	Welding Neck	Blind
						Slip-on/Socket Welding (mm) Y	Welding Neck (mm) Y	Slip-on/Socket Welding min (mm) B	Welding Neck / Socket Welding (mm) B	Circle Diam. (mm) K	Hole Diam. (mm) H	Bolts (No.)	RF Stud Bolt Length (mm)			
15	½	135	30.2	43	21.3	40	73	22.9	Note (1)	88.9	22.2	4	120	3.0	3.2	3.2
20	¾	140	31.8	51	26.7	43	79	28.2	Note (1)	95.2	22.2	4	125	3.6	4.1	4.5
25	1	160	35.0	57	33.4	48	89	34.9	Note (1)	108.0	25.4	4	140	5.0	5.5	5.4
32	1 ¼	185	38.1	73	42.2	52	95	43.7	Note (1)	130.2	28.6	4	150	7.3	9.1	8.2
40	1 ½	205	44.5	79	48.3	60	111	50.0	Note (1)	146.0	31.8	4	170	10	11	10
50	2	235	50.9	95	60.3	70	127	62.5	Note (1)	171.4	28.6	8	180	17	19	18
65	2 ½	265	57.2	114	73.0	79	143	75.4	Note (1)	196.8	31.8	8	195	24	24	25
80	3	305	66.7	133	88.9	92	168	91.4	Note (1)	228.6	34.9	8	220	36	43	39
100	4	355	76.2	165	114.3	108	190	116.8	Note (1)	273.0	41.3	8	255	54	64	60
125	5	420	92.1	203	141.3	130	229	144.4	Note (1)	323.8	47.6	8	300	93	111	101
150	6	485	108.0	235	168.3	152	273	171.4	Note (1)	368.3	54.0	8	345	143	176	157
200	8	550	127.0	305	219.1	178	318	222.2	Note (1)	438.2	54.0	12	380	213	261	241
250	10	675	165.1	375	273.0	229	419	277.4	Note (1)	539.8	66.7	12	490	409	484	465
300	12	760	184.2	441	323.8	254	464	328.2	Note (1)	619.1	73.0	12	540	573	692	664

These flanges are available in a very wide range of sizes, ratings and types in 304/304L and 316/316L. Other grades such as 2205 are available subject to enquiry.

Stainless Steel Table Flanges – Dimensions & Weights

These diagrams relate to the tables of flange specified dimensions on the following pages. Refer note below regarding terminology of Table flange types.

Types of Table Flanges specified in AS 2129, AS 4087 & EN 1092

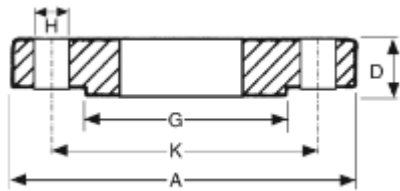
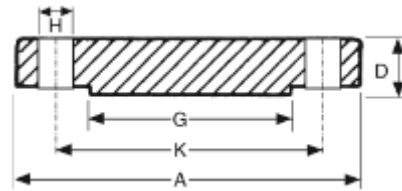
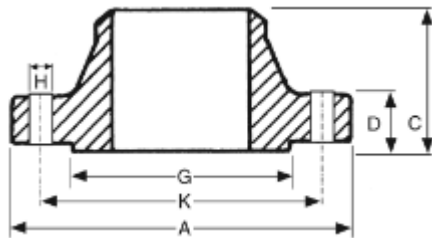

PLATE
"SLIP-ON WELDING"



BLIND
("BLANK")



WELDING NECK (WN)

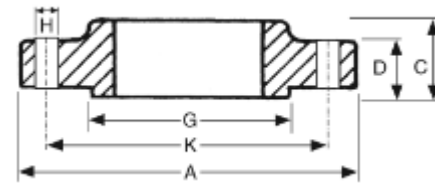

BOSS

Notes to these diagrams and the following tables of dimensions.

- Diagrams above show the optional Raised Face.
- Standard Atlas Steels Table Flange stock is Flat Faced.
- All weights are approximate
- A diametrical clearance of 4mm maximum applies to pipe or tube OD for plate flanges
- The flange thickness "D" dimension includes the raised face height, if a non-standard raised sealing face is present.
- Welding Neck bore is derived from the pipe schedule
- Atlas standard stock table flanges are plate and blind type. Note that AS2129 plate flanges are usually referred to by end users as "slip-on welding" flanges and this terminology is also used in Atlas product descriptions.
- PN16 "DIN" flanges to EN1092-1 and AS4087 waterworks flanges are also available subject to enquiry.

Stainless Steel Table Flanges – Dimensions & Weights

Nominal Size	Dimensions (mm)							Weight (kg)	
	DN	OD A	Thickness D	Raised Face Diam G	Drilling			Bolt Size & Thread	SOW
Bolt Circle Diam K					Bolt Hole Diam H	Number of Bolts			
15	95	*5	47	67	14	4	M12	0.6	0.6
20	100	*5	53	73	14	4	M12	0.7	0.7
25	115	*5	65	83	14	4	M12	0.9	1.0
32	120	*6	67	87	14	4	M12	0.9	1.1
40	135	*6	78	98	14	4	M12	1.2	1.4
50	150	*8	90	114	18	4	M16	1.4	1.7
65	165	*8	103	127	18	4	M16	1.6	2.1
80	185	*10	122	146	18	4	M16	2.0	2.7
90	205	*10	141	165	18	4	M16	2.2	3.2
100	215	*10	154	178	18	4	M16	2.5	3.6
125	255	13	186	210	18	8	M16	3.3	4.9
150	280	13	211	235	18	8	M16	4.0	6.1
200	335	13	268	292	18	8	M16	5.0	8.8
250	405	16	328	356	22	8	M20	8.7	15.8
300	455	19	378	406	22	12	M20	11.3	23.6
350	525	22	438	470	26	12	M24	19.6	38.6
400	580	22	489	521	26	12	M24	22.3	44.9
450	640	25	532	584	26	12	M24	29.0	63.0
500	705	29	609	641	26	16	M24	39.9	86.0
550	760	29	637	699	30	16	M27	50.0	107.0
600	825	32	720	756	30	16	M27	58.0	125.0
700	910	35	809	845	30	20	M27		
750	995	41	888	927	33	20	M30		
800	1060	41	942	984	36	20	M33		
850	1090	44	974	1016	36	20	M33		
900	1175	48	1050	1092	36	24	M33		
1000	1255	51	1133	1175	36	24	M33		
1200	1490	60	1368	1410	36	32	M33		

Nominal Size	Dimensions (mm)							Weight (kg)	
	DN	OD A	Thickness D	Raised Face Diam G	Drilling			Bolt Size & Thread	SOW
Bolt Circle Diam K					Bolt Hole Diam H	Number of Bolts			
15	95	*6	47	67	14	4	M12	0.6	0.7
20	100	*6	53	73	14	4	M12	0.7	0.8
25	115	*7	63	83	14	4	M12	0.9	1.0
32	120	*8	67	87	14	4	M12	1.0	1.1
40	135	*9	78	98	14	4	M12	1.2	1.4
50	150	*10	90	114	18	4	M16	1.4	1.7
65	165	*10	103	127	18	4	M16	1.6	2.1
80	185	*11	122	146	18	4	M16	2.0	2.7
90	205	12	141	165	18	8	M16		
100	215	13	154	178	18	8	M16	2.5	3.6
125	255	14	186	210	18	8	M16	3.7	5.5
150	280	17	207	235	22	8	M20	5.0	8.3
200	335	19	264	292	22	8	M20	7.1	12.9
250	405	22	328	356	22	12	M20	11.4	21.9
300	455	25	374	406	26	12	M24	15.1	31.8
350	525	29	438	470	26	12	M24	25.3	47.6
400	580	32	489	521	26	12	M24	31.3	66.0
450	640	35	552	584	26	16	M24	40.8	87.0
500	705	38	609	641	26	16	M24	53.0	114.0
550	760	44	663	699	30	16	M27		
600	825	48	717	756	33	16	M30	85.0	195.0
700	910	51	806	845	33	20	M30		
750	995	54	885	927	36	20	M33		
800	1060	54	942	984	36	20	M33		
850	1090	57	974	1016	36	20	M33		
900	1175	64	1050	1092	36	24	M33		
1000	1255	67	1130	1175	39	24	M36		
1200	1490	79	1365	1410	39	32	M36		

Stainless Steel Table Flanges – Dimensions & Weights

Nominal Size	Dimensions (mm)							Weight (kg)		
	DN	OD A	Thickness D	Raised Face Diam G	Drilling			Bolt Size & Thread	SOW	Blind
					Bolt Circle Diam. K	Bolt Hole Diam H	Number of Bolts			
15	95	10	47	67	14	4	M12	0.6	0.7	
20	100	10	53	73	14	4	M12	0.7	0.8	
25	120	10	63	87	18	4	M16	0.9	1.0	
32	135	13	74	98	18	4	M16	1.1	1.3	
40	140	13	81	105	18	4	M16	1.2	1.4	
50	165	16	103	127	18	4	M16	2.2	2.6	
65	185	16	122	146	18	4	M16	2.5	3.0	
80	205	16	141	165	18	8	M16	3.0	3.8	
90	215	19	154	178	18	8	M16			
100	230	19	167	191	18	8	M16	4.3	5.9	
125	280	22	207	235	22	8	M20	7.4	10.1	
150	305	22	232	260	22	12	M20	8.1	11.9	
200	370	35	296	324	22	12	M20	12.7	20.3	
250	430	29	349	381	26	12	M24	18.1	31.4	
300	490	32	406	438	26	16	M24	23.9	44.7	
350	550	35	459	495	30	16	M27	35.3	63.0	
400	610	41	516	552	30	20	M27	47.6	90.0	
450	675	44	571	610	33	20	M30	62.0	120.0	
500	735	51	634	673	33	24	M30	80.0	162.0	
550	785	54	685	724	33	24	M30			
600	850	57	739	781	36	24	M33	112.0		
700	935	60	815	857	36	24	M33			
750	1015	67	898	940	36	28	M33			
800	1060	68	942	984	36	28	M33			
850	1090	70	974	1016	36	32	M33			
900	1185	76	1060	1105	39	32	M36			
1000	1275	83	1149	1194	39	36	M36			
1200	1530	95	1385	1441	42	40	M39			

Nominal Size	Dimensions (mm)							Weight (kg)		
	DN	OD A	Thickness D	Raised Face Diam. G	Drilling			Bolt Size & Thread	SOW	Blind
					Bolt Circle Diam. K	Bolt Hole Diam H	Number of Bolts			
15	115	57	57	83	18	4	M16	0.8	1.0	
20	115	57	57	83	18	4	M16	0.9	1.0	
25	120	64	64	87	18	4	M16	1.1	1.2	
32	135	76	76	98	18	4	M16	1.5	1.8	
40	140	83	83	105	18	4	M16	1.7	2.0	
50	165	102	102	127	18	4	M16	2.6	3.1	
65	185	114	114	146	18	8	M16	3.1	3.8	
80	205	127	127	165	18	8	M16	4.3	5.4	
90	215	140	140	178	18	8	M16			
100	230	152	152	191	18	8	M16	5.8	7.9	
125	280	178	178	235	22	8	M20	9.9	12.6	
150	305	210	210	260	22	12	M20	10.8	15.4	
200	370	260	260	324	22	12	M20	18.3	28.2	
250	430	311	311	381	26	12	M24	22.1	38.0	
300	490	362	362	438	26	16	M24	31.0	58.0	
350	550	419	419	495	30	16	M27	47.7	85.0	
400	610	483	483	552	30	20	M27	62.0	118.0	
450	675	533	533	610	33	20	M30	105.0	196.0	
500	735	597	597	673	33	24	M30			
550	785	648	648	724	33	24	M30			
600	850	699	699	781	36	24	M33			

Stainless Steel Pipe, Fittings & Flanges



PN16 Flanges to AS 4087								
Nominal Size DN	Dimensions							Bolt Size & thread
	OD A	Raised Face Height	Raised Face Diam G	Thickness D	Bolt Circle Diam K	Number of Holes	Hole Diameter H	
50	150	3	90	11	114	4	18	M16
65	165	3	103	11	127	4	18	M16
80	185	3	122	11	146	4	18	M16
100	215	3	154	13	178	4	18	M16
150	280	3	211	13	235	8	18	M16
165	280	3	211	13	235	8	18	M16
200	335	3	268	19	292	8	18	M16
225	370	3	300	19	324	8	18	M16
250	405	3	328	19	356	8	22	M20
300	455	4	378	23	406	12	22	M20
350	525	4	438	30	470	12	26	M24
375	550	4	463	30	495	12	26	M24
400	580	4	489	30	521	12	26	M24
450	640	4	552	30	584	12	26	M24
500	705	4	609	38	641	16	26	M24
600	825	5	720	48	756	16	30	M27
700	910	5	809	56	845	20	30	M27
750	995	5	888	56	927	20	33	M30
800	1060	5	942	56	984	20	36	M33
900	1175	5	1050	66	1092	24	36	M33
1000	1255	5	1133	66	1175	24	36	M33
1200	1490	5	1368	76	1410	32	36	M33

PN16 Flanges to EN 1092									
Nominal Size DN	Dimensions								Bolt Size & thread
	OD A	Raised Face Height	Raised Face Diam G	Thickness Blind	Thickness SOW D	Bolt Circle Diam K	Number of Holes	Hole Diameter H	
15	95.0	2	45	16	14	65	4	14	M12
20	105.0	2	58	18	16	75	4	14	M12
25	115	2	68	18	16	85	4	18	M12
32	140	2	78	18	18	100	4	18	M16
40	150	3	88	18	18	110	4	18	M16
50	165	3	102	18	20	125	4	18	M16
65	185	3	122	18	20	145	8	18	M16
80	200	3	138	20	20	160	8	18	M16
100	220	3	158	20	22	180	8	18	M16
125	250	3	188	22	22	210	8	18	M16
150	285	3	212	22	24	240	8	22	M20
165	285	3	212	22	24	240	8	22	M20
200	340	3	268	24	26	295	12	22	M20
250	405	3	320	26	29	355	12	26	M24
300	460	4	378	28	32	410	12	26	M24
350	520	4	438	30	35	470	16	26	M24
400	580	4	490	32	38	525	16	30	M27
450	640	4	550	40	42	585	20	30	M27
500	715	4	610	44	46	650	20	33	M30
600	840	5	725	54	55	770	20	36	M33
700	910	5	795	58	63	840	24	36	M33
800	1025	5	900	62	74	950	24	39	M36
900	1125	5	1000	64	82	1050	28	39	M36

Screwed Low Pressure “150lb” BSP 316 Fittings



Product range and theoretical weights (kg)												
DN	Round socket	Pipe nipple TBE	Pipe nipple TOE	Hex/round cap	Hex nipple	3 pce union	Female 90° elbow	Male/fem 90° elbow	Female tee	Hex head plug	Hex locknut	Square head plug
6	0.02	0.02	0.01	0.02	0.02	0.13	0.03	0.02	0.05	0.02	0.02	0.01
8	0.04	0.03	0.02	0.03	0.03	0.11	0.04	0.04	0.05	0.03	0.02	0.02
10	0.05	0.04	0.03	0.03	0.05	0.18	0.06	0.06	0.09	0.03	0.03	0.03
15	0.09	0.08	0.05	0.07	0.08	0.22	0.10	0.11	0.14	0.05	0.04	0.03
20	0.13	0.11	0.08	0.10	0.11	0.33	0.14	0.16	0.21	0.09	0.05	0.07
25	0.20	0.16	0.11	0.17	0.17	0.50	0.27	0.26	0.36	0.12	0.10	0.10
32	0.29	0.29	0.19	0.24	0.25	0.70	0.38	0.40	0.50	0.19	0.14	0.15
40	0.34	0.35	0.23	0.38	0.37	0.87	0.51	0.50	0.70	0.27	0.15	0.21
50	0.52	0.58	0.30	0.47	0.53	1.39	0.75	0.82	1.01	0.40	0.25	0.31
65	0.78	0.92	0.57	0.85	1.14	2.07	1.69	1.68	2.41	0.76	0.51	0.59
80	1.05	1.45	0.86	1.24	1.37	2.98	2.33	2.06	3.32	1.03	0.55	0.71
100	1.90	2.07	1.38	2.09	1.90	4.82	3.43	3.45	4.81	1.66	0.92	1.10

TBE = Threaded Both Ends
 TOE = Threaded One End

Screwed Low Pressure “150 lb” BSP 316 Fittings



BSP Fittings

Dimensions: generally to ISO4144.

Threading: BS21 (ISO 7-1).

Feed materials – sockets, TOE nipples, TBE nipples
manufactured from stainless steel pipe to ASTM A312M.

- Other fittings made from investment castings.

Product range and theoretical weights (kg)		
DN	Hex reducing bush	Hex reducing nipple
8x6	0.01	0.03
10x6	0.02	0.05
10x8	0.03	0.05
15x6	0.04	0.08
15x8	0.06	0.08
15x10	0.06	0.08
20x8	0.08	0.12
20x10	0.07	0.12
20x15	0.05	0.12
25x10	0.14	0.17
25x15	0.12	0.17
25x20	0.08	0.17
32x25	0.15	0.26
40x20	0.33	0.36
40x25	0.26	0.36
40x32	0.17	0.36
50x25	0.56	0.50
50x32	0.45	0.50
50x40	0.37	0.50
65x50	0.51	0.85
80x50	0.94	1.28
80x55	1.23	1.28

Screwed Class 3000 NPT Fittings – ASTM A182M and ASME B16.11



Grade 316

Product range and theoretical weights (kg)												
DN	Hex cap	Coupling	45° Elbow	90° Elbow	Hex nipple	Hex plug	Union	Female tee	Schedule 40S		Schedule 80S	
									Nipple TBE	Nipple TOE	Nipple TBE	Nipple TOE
8	0.05	0.06	0.13	0.14	0.03	0.03	0.21	0.20	0.06	0.05	0.08	0.06
10	0.06	0.07	0.25	0.27	0.06	0.06	0.27	0.31	0.08	0.06	0.11	0.09
15	0.13	0.14	0.36	0.37	0.08	0.08	0.46	0.49	0.13	0.09	0.16	0.10
20	0.21	0.20	0.53	0.60	0.15	0.15	0.61	0.80	0.17	0.12	0.22	0.16
25	0.37	0.30	0.78	1.08	0.24	0.24	0.99	1.31	0.24	0.18	0.31	0.23
32	0.60	0.73	1.02	1.22	0.37	0.37	1.55	1.61	0.33	0.24	0.44	0.35
40	0.73	1.03	1.70	2.45	0.45	0.45	1.90	3.20	0.40	0.30	0.53	0.40
50	1.10	1.35	2.35	2.50	0.76	0.76	2.86	3.55	0.53	0.40	0.74	0.56

TBE = Threaded Both Ends

TOE = Threaded One End

Grade 304

Product range and theoretical weights (kg)					
DN	Coupling	90° Elbow	Hex nipple	Hex plug	Union
15	0.11	0.41	0.08	0.07	0.30
20	0.20	0.68	0.17	0.13	0.58
25	0.29	1.02	0.38	0.20	0.76
32	0.73	1.22	0.37	0.41	1.55
40	1.00	2.44	0.63	0.60	1.60
50	1.42	2.52	1.10	1.10	2.42

Class 6000 and 9000

Higher pressure fittings are available subject to enquiry

Screwed Class 3000 NPT 316 Fittings – ASTM A182M and ASME B16.11



Product range and theoretical weights (kg)				
DN	Hex reducing bush	Hex reducing nipple	Swage nipple TBE 80S	Reducing insert
8x6	0.02	0.05	0.04	0.04
10x6	0.02	0.06	0.06	0.05
10x8	0.03	0.06	0.06	0.05
15x6	0.04	0.08	0.14	0.10
15x8	0.06	0.08	0.14	0.10
15x10	0.06	0.08	0.18	0.10
20x8	0.08	1.15	0.18	0.12
20x10	0.07	0.17	0.18	0.12
20x15	0.05	0.17	0.18	0.12
25x8	0.12	0.38	0.25	0.16
25x10	0.14	0.38	0.25	0.16
25x15	0.12	0.38	0.25	0.16
25x20	0.12	0.38	0.25	0.16
40x15	0.21	0.63	0.60	0.45
40x20	0.21	0.63	0.60	0.45
40x25	0.21	0.63	0.60	0.45
40x32	0.21	0.64	0.60	0.45
50x25	0.45	0.68	1.14	0.70
50x40	0.50	0.70	1.14	0.70

TBE = Threaded Both Ends

Class 6000 and 9000

Higher pressure fittings are available subject to enquiry

Socket Weld Class 3000 Fittings – ASTM A182M and ASME B16.11



Grade 316L

Product range and theoretical weights (kg)						
DN	Cap	Coupling	45° Elbow	90° Elbow	Equal tee	Union
8	0.06	0.07	0.25	0.26	0.30	0.21
15	0.12	0.14	0.36	0.36	0.50	0.30
20	0.21	0.20	0.53	0.60	0.80	0.50
25	0.40	0.40	0.80	1.10	1.31	0.80
32	0.60	0.70	1.00	1.20	1.61	1.20
40	0.70	1.00	1.70	2.40	3.20	1.50
50	1.10	1.30	2.30	2.50	3.50	2.30

Grade 316L Reducing Inserts

Product range and theoretical weights (kg)			
DN	Reducing inserts	DN	Reducing inserts
20x15	0.12	40x25	0.45
25x15	0.16	50x25	0.7
25x20	0.16	50x40	0.7
40x20	0.45		

Class 6000 and 9000 higher pressure rated fittings are available subject to enquiry.

Socket Weld Class 3000 Fittings – ASTM A182M and ASME B16.11**Grade 304L**

Product range and theoretical weights (kg)						
DN	Cap	Coupling	45° Elbow	90° Elbow	Equal tee	Union
8	0.06	0.07	0.25	0.26	0.30	0.21
15	0.12	0.14	0.36	0.36	0.50	0.30
20	0.21	0.20	0.53	0.60	0.80	0.50
25	0.40	0.40	0.80	1.10	1.31	0.80
32	0.60	0.70	1.00	1.20	1.61	1.20
40	0.70	1.00	1.70	2.40	3.20	1.50
50	1.10	1.30	2.30	2.50	3.50	2.30

Branch Outlet Class 3000 304L and 316L – ASTM A182M and ASME B16.11

Product range and theoretical weights (kg)						
DN	Socket outlet 304L	Threaded outlet 304L	Welding outlet 304L	Socket outlet 316L	Threaded outlet 316L	Welding outlet 316L
15	0.15	0.12	0.13	0.15	0.12	0.13
20	0.17	0.24	0.24	0.17	0.24	0.24
25	0.27	0.38	0.38	0.27	0.38	0.38
40	0.48	0.66	0.66	0.48	0.66	0.66
50	0.07	1.02	1.02	0.75	1.02	1.02

Class 6000 and 9000

Higher pressure fittings are available subject to enquiry

Stainless Steel Tube and Fittings



4 Stainless Steel Tube and Fittings



4

Stainless Steel Tube and Fittings



Stainless steel tube is typically specified by OD (outside diameter) or A/F (across flat) dimensions, WT (wall thickness), grade, condition and surface finish.

It is resistant to many forms of corrosion, has hygienic sterile properties, high quality aesthetic appeal and exceptional strength.

Tube is manufactured in round, square and rectangular sections in a variety of wall thicknesses and usually by the processes of longitudinal welding, hot and cold drawing (seamless) or spiral welding.

Finishes or appearance range from unpolished to very highly polished. Unpolished has a 2B mill finish, standard polished is a finely grit polished finish and there is a finer buffed finish giving close to a mirror appearance. Finishes are selected to suit application and aesthetic appeal.

Stainless steel tube can be joined by welding, which facilitates rigidity in construction, or by the use of mechanical fittings which enables dismantling for hygienic cleaning.

The tubular products system incorporates a comprehensive range of stainless steel fittings in the form of elbows, tees, reducers and flanges in various sizes, wall thickness, grades and finishes to suit tube dimensions and tolerances.

As-Welded (AW) Tube

Decorative & Structural Tube – This tubing is produced direct off the continuous tube welding mill, using cold rolled stainless steel strip made to ASTM standards, with tube produced to commercial limits of straightness in standard or specific customer lengths.

AW tube is generally used for structural and decorative applications in mildly corrosive conditions. It is not suitable for applications requiring significant flaring, expanding or bending, nor for fluid transfer or pressure applications.

AW tube is also available with one or two rebate slots for support of architectural glass panels.

SupaBrite Mirror Polished Tube – This As-Welded tube is ideal for decorative structural applications **where a highly reflective appearance is desired, such as prestigious hand rails. The bright finish is not** only aesthetically attractive but also gives high corrosion resistance and ease of maintenance.

Manufacturing specification: ASTM A554.

Food Quality Tube – As-welded food quality tube is stocked by Atlas Steels. This tube at the point of manufacture goes through a process where the internal weld bead is rolled to blend in with the surrounding tube wall profile. The result is an improved internal finish along the weld, reducing the chance of a crevice where liquid or food product may be trapped. This assists with 'clean in place' (CIP) of food and beverage process lines and other applications such as the pharmaceutical industry. Further assurance of reliability of food tube comes from the 100% weld NDT mandatory for this product.

Complimenting the food quality tube is an extensive range of fittings, also intended for hygienic applications. These are also covered by AS 1528 and include butt welding, screwed and clamp fittings.

Manufacturing specification: AS 1528

As-Welded Annealed (AWA) Tube

This tube is produced by the same process as AW tube but is then annealed to relieve stresses and improve ductility. Bright annealing is carried out in a controlled-atmosphere furnace, so that no oxide or scale is formed on the surface.

Annealing both increases the corrosion resistance and softens the tube which allows severe manipulation such as bending, expanding and forming.

Manufacturing specification: ASTM A269M

Cold Worked Annealed (CWA) Tube

This tube is typically destined for heat exchanger applications and is produced in a similar way to AWA product except that the internal bead is rolled flush with the inside tube surface prior to annealing. Because of the critical end use this tube undergoes extensive testing as part of the manufacturing process.

Manufacturing specification: ASTM A249M

Cold Drawn Seamless (CDS) Tube

This tube is produced by drawing from hollow billets. It is usually supplied in the annealed and pickled condition and used where service conditions involve high pressure and corrosive conditions and where good surface finish and close tolerances are required, e.g. heat exchanger and condenser tubing, instrumentation tubing and some refinery applications. Seamless tubing is always recommended for applications using compression fittings sealing on the inside surface.

Manufacturing specification: ASTM A269M for general service. ASTM A213M for heat exchanger service and A268M for ferritic and martensitic tubes.

Spiral Welded Tube

This tube is produced by the helical forming and automatic welding of a continuous strip of stainless steel.

Typical applications include water and pulp in paper mills, product and effluent lines in chemical processing, water lines for brewing, dust fume extraction, furnace and boiler flues, stormwater down-pipes in high-rise applications and ventilation ducts and condensation lines for air-conditioning.

Manufacturing specification: generally to ASTM A778M, except mechanical properties are not generally tested or reported.

Grades:

Austenitic	304, 304L, 316, 316L, 321
Ferritic	409
Duplex	2205

Table Flanges are available bored for tube. These flanges are covered in the section of this Atlas Product Reference Manual on Stainless Steel Pipe.

A note on product weights

This product Reference Manual gives weights and weights per metre for many products. These are intended to be useful, but please note that standard dimensional tolerances mean these weights will always be approximate only.

Stainless Steel Round Tube – Specifications refer pages 3 – 4

OD		WT	Weight	Type of Tube				
				A554 320 Grit	AS 1528	A554 600 Grit	A554 Mirror	Seamless
mm	inch	mm	kg/m					
4.76	3/16	0.50	0.05					
		0.70	0.07					
		0.90	0.09					
6.35	1/4	0.50	0.07					
		0.70	0.10					
		0.90	0.12					✓
		1.20	0.15					✓
		1.60	0.19					✓
7.94	5/16	0.50	0.09					
		0.70	0.13					
		0.90	0.16					✓
		1.20	0.20					✓
		1.60	0.25					✓
9.52	3/8	0.50	0.11					
		0.70	0.15					
		0.90	0.19	✓				✓
		1.20	0.25	✓				✓
12.70	1/2	0.50	0.15					
		0.70	0.21					
		0.90	0.26					✓
		1.20	0.34	✓				✓
15.88	5/8	0.50	0.19					
		0.70	0.26					
		0.90	0.33					
		1.20	0.44	✓				✓
19.05	3/4	0.50	0.23					
		0.70	0.32					
		0.90	0.41					
		1.20	0.53	✓				✓
22.22	7/8	0.90	0.48					
		1.20	0.63	✓				
		1.60	0.82	✓				✓
		2.00	1.06					
25.40	1	0.50	0.31					
		0.70	0.43					
		0.90	0.55					
		1.20	0.72	✓				
		1.60	0.94	✓	✓	✓	✓	✓
		2.00	1.16					✓
		2.50	1.42					
31.75	1 1/4	0.90	0.69					
		1.20	0.91	✓				
		1.60	1.20	✓	✓	✓	✓	
		2.00	1.48					
		2.50	1.81					

OD		WT	Weight	Type of Tube				
				A554 320 Grit	AS 1528	A554 600 Grit	A554 Mirror	Seamless
mm	inch	mm	kg/m					
38.10	1 1/2	0.90	0.83					
		1.20	1.10	✓				
		1.60	1.45	✓	✓	✓	✓	
		2.00	1.79					
		2.50	2.21					
		3.00	2.61	✓				✓
		3.20	2.77					
44.45	1 3/4	0.90	0.97					
		1.20	1.29					
		1.60	1.70	✓				
		2.00	2.11					
		2.50	2.60					
		3.20	3.27					
50.80	2	0.90	1.11					
		1.20	1.48	✓				
		1.60	1.95	✓	✓	✓	✓	
		2.00	2.42					
		2.50	3.00					
		3.00	3.56	✓				✓
63.50	2 1/2	1.20	1.85					
		1.60	2.46	✓	✓	✓	✓	
		2.00	3.05					
		2.50	3.78					
76.20	3	1.20	2.23					
		1.60	2.96	✓	✓	✓		
		2.00	3.68					
		2.50	4.57					
88.90	3 1/2	1.60	3.46					
		2.00	4.31					
		2.50	5.36					
		3.20	6.80					
101.60	4	1.60	3.97	✓	✓	✓		
		2.00	4.94					
		2.50	6.15					
127.00	5	3.20	7.81					
		1.60	4.98		✓			
		2.00	6.20					
152.40	6	2.50	7.72					
		3.20	9.83					
		1.60	5.99	✓	✓			
		2.00	7.46					
204	8	2.50	9.30					
		3.20	11.84					
		1.60	8.00					
		2.00	9.98	✓				

- **A554 320 GRIT** = as-welded mechanical tube
- **AS 1528** = Food Grade as-welded tube typically in 320 grit polish finish
- **A554 600 Grit** = bright finish polished tube
- **Mirror Finish** = mirror-polished tube
- **Seamless** = Cold-Drawn Seamless Tube

- Tubes are available in 304 and a lesser range of 316 grade.
- AWA annealed welded tube (ASTM A269M) is available subject to special enquiry.
- Most tube is 320 grit external polished; some also available in SupaBrite, 600 grit and unpolished.
- Slotted tube is also obtainable in 600 grit or 320 grit polished finish – single slot or double slots at 90° or 180°.

Stainless Steel Square Tube – Specifications refer pages 3 - 4

Mostly stocked in 304, more common sizes in both 304 and 316. Finish: polished for all stock.

Product Size Range and Weight (kg/m)							
A/F Dimensions		Wall Thickness (mm)					
mm	inches	1.2	1.6	2.0	3.0	5.0	6.0
12.70	½	0.44					
19.05	¾	0.68	0.88				
25.40	1	0.92	1.20	1.48			
31.75	1 ¼	1.16	1.52	1.88			
38.10	1 ½	1.40	1.85	2.28			
40.00	-				3.51		
50.00	-				4.46		
50.80	2		2.49	3.08			
80.00	-			4.93	7.30		
100.00	-				9.20	15.00	17.82
150.00	-				13.94	22.91	

Stainless Steel Rectangular Tube

Mostly stocked in 304, more common sizes in both 304 and 316. Finish: polished for all stock.

Product Size Range and Weight (kg/m)							
Dimensions		Wall Thickness (mm)					
mm	inches	1.2	1.6	2.0	3.0	5.0	6.0
50.0 x 25.0	-		1.82		3.27		
50.8 x 25.4	2 x 1	1.40	1.85				
60.0 x 40.0	-				4.46		
80.0 x 40.0	-			3.67	5.40		
100.0 x 50.0	-			4.61	6.83	11.1	13.1
150.0 x 100.0	-				12.0	19.0	22.6
200.0 x 100.0	-						27.3

SupaBrite Mirror Polished Tube

OD or A/F Size (mm)	Wall thickness (mm)	Length (mm)	Shape	PE protected
19.05	1.6	6000	Round	✓
22.23	1.6	6000	Round	✓
25.4	1.6	6000	Round	✓
31.75	1.6	6000	Round	✓
38.1	1.6	6000	Round	✓
38.1	3.0	6000	Round	✓
50.8	1.6	6000	Round	✓
50.8	3.0	6000	Round	✓
63.5	1.6	6000	Round	✓
50.8 x 50.8	1.6	6000	Square	✓
50.8 x 50.8	3.0	6000	Square	✓
38.1 x 38.1	1.6	6000	Square	✓
38.1 x 38.1	3.0	6000	Square	✓
50 x 25	1.6	6000	Rectangular	✓
50 x 10	1.6	6000	Rectangular	✓
60 x 10	1.6	6000	Rectangular	✓

Special non-standard sizes are available on request.

Grade 304 and 316 Stainless Steel Spiral Welded Tube – Specification refer pages 3 - 4

Product Size Range and Weight (kg/m)							
Dimensions		Wall thickness (mm)					
mm	Inches	1.6	2	2.5	3	3.5	4
76.20	3	3.00	3.80				
101.6	4	4.00	5.00	6.30			
127.0	5	5.00	6.30	7.90	9.50		
152.4	6	6.10	7.60	9.50	11.40	13.20	
203.2	8	8.10	10.10	12.60	15.10	17.70	20.20
254.0	10	10.10	12.60	15.80	18.90	22.10	25.20
304.8	12	12.10	15.10	18.90	22.70	26.50	30.30
355.6	14	14.10	17.70	22.10	26.50	30.90	35.30
406.4	16	16.10	20.20	25.20	30.30	35.30	40.40
457.2	18	18.20	22.70	28.40	34.10	39.70	45.40
508.0	20	20.20	25.20	31.50	37.80	44.10	50.50
538.8	22	22.20	27.70	34.70	41.60	48.60	55.50
609.6	24		30.30	37.80	45.40	53.00	60.50
762.0	30		37.80	47.30	56.80	66.20	75.70
1016.0	40				75.70	88.30	100.90

- Grades 304, 304L, 316, 316L, 321, 409 and 2205 can be produced in spiral welded tube.
- Also available in 5mm wall thickness from 355.5 mm diameter.
- Larger sizes up to 1500mm diameter can be manufactured.
- Pipe sizes DN80/NPS3 and above can be manufactured.
- Special sizes can also be manufactured.
- Lobster back bends, fabricated tees, angle neck rings and galvanized or stainless steel backing flanges are also available to match spiral welded tube.

Tube Fittings

Complementing our stock of round tube is a range of tube fittings. The more common tube fittings include bends, tees, reducing tees, eccentric and concentric reducers, BSM unions and tube clamps.

Tube bends – Bends are generally stocked as 45, 90 or 180 degree. Three common manufacturing processes are pulled bends (cold drawn bend), pressed bends and lobster back bends. The process of manufacturing often relates to the diameter of the tube and thickness of material used. Up to and including 152.4mm the bends are generally pulled, by far the most commonly supplied bends. Pressed bends can be from 101.6 to 305mm OD. Lobster back bends are generally supplied in diameters 101.6mm and above and these bends are used generally to suit spiral welded tube.

To maintain a level of quality and consistency Atlas stocks pulled bends with an extended leg. The importance of this style of bend ensures each end of the bend is finished off true and accurate. The extended leg gives the ability to maintain the original circularity of the tube and a precise 45 or 90 degree radius measured from across the end face of the bends.

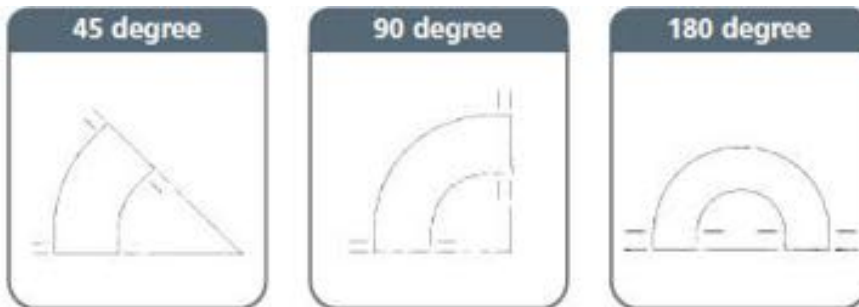

Tees – Two common processes of manufacturing are welded or pulled tees. To maintain product quality and consistency welded tees are stocked as opposed to pulled tees.

Tees are stocked in two forms; equal or reducing. An equal tee has all three branches of the tee equal in diameter. A reducing tee has a reduced diameter of tube on the branch section of the tee.

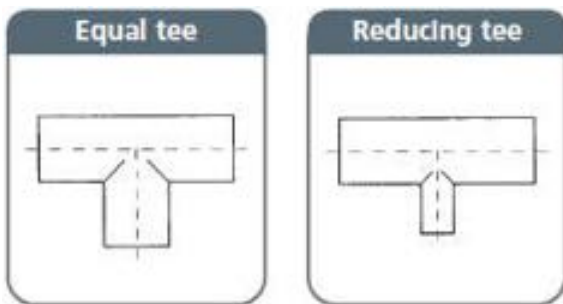

As tube fittings are often used in the food industry and both aesthetics and hygiene are important many of these fittings are stocked in an externally polished finish.

Stainless Steel Butt Welding Tube Fittings

Commonly stocked as 304 and 316. Finish: polished or unpolished.

Product size range and weight (kg/m)									
Dimensions OD		Bends 45 degree		Bends 90 degree		Bends 180 degree		Equal tee	
		Wall thickness (mm)		Wall thickness (mm)		Wall thickness (mm)		Wall thickness (mm)	
mm	Inches	1.6	2	1.6	2	1.6	2	1.6	2
9.52	$\frac{3}{8}$	0.01		0.01		0.01		0.03	
12.70	$\frac{1}{2}$	0.01		0.01		0.01		0.05	
19.05	$\frac{3}{4}$	0.02		0.02		0.03		0.08	
25.40	1	0.03		0.04		0.05		0.13	
31.75	1 $\frac{1}{4}$	0.05		0.06		0.08		0.20	
38.10	1 $\frac{1}{2}$	0.07		0.08		0.11		0.30	
50.80	2	0.12		0.15		0.20		0.50	
63.50	2 $\frac{1}{2}$	0.18		0.23		0.31		0.80	
76.20	3	0.27		0.34		0.45		1.10	
101.6	4	0.48		0.60		0.80		1.60	
127.0	5	0.75		0.95		1.26		1.80	
152.4	6		1.36		1.70		2.26		5.40
203.2	8		2.42		3.02		4.03		8.40
254.0	10		3.49		4.50		5.05		9.90

- Usual stock range is 1.6mm wall thickness up to 127mm diameter, and 2.0mm wall thickness for larger sizes.
- Specification: AS 1528.3. Sizes over 127mm are usually to EN 10253-3 or EN 10253-4.
- Standard stock includes a straight “extended leg” on all bends.
- Other fittings do not have the extended leg.

Stainless Steel Reducing Tube Fittings

Commonly stocked as 316. Finish: polished.

Product size range and weight (kg/m)									
Dimensions OD		Con reducer	Ecc reducer	Reducing tees	Dimensions OD		Con reducer	Ecc reducer	Reducing tees
		Wall thickness (mm)					Wall thickness (mm)		
mm	mm	1.6	1.6	1.6	mm	mm	1.6	1.6	1.6
19.05	12.70	0.02	0.02	0.08	76.20	50.80	0.25	0.25	1.10
25.40	12.70	0.04	0.04	0.13	76.20	63.50	0.25	0.25	1.10
25.40	19.05	0.04	0.04	0.13	101.6	25.40	0.30	0.30	1.60
31.75	12.70	0.05	0.05	0.20	101.6	38.10	0.30	0.30	1.60
31.75	25.40	0.05	0.05	0.20	101.6	50.80	0.30	0.30	1.60
38.10	12.70	0.05	0.05	0.30	101.6	63.50	0.30	0.30	1.60
38.10	19.05	0.05	0.05	0.30	101.6	76.20	0.30	0.30	1.60
38.10	25.40	0.05	0.05	0.30	127.0	50.80	0.60	0.60	1.80
38.10	31.75	0.05	0.05	0.30	127.0	63.50	0.60	0.60	1.80
50.80	12.70	0.10	0.10	0.50	127.0	76.20	0.60	0.60	1.80
50.80	19.05	0.10	0.10	0.50	127.0	101.6	0.60	0.60	1.80
50.80	25.40	0.10	0.10	0.50	152.4	50.80	0.70	0.70	2.80
50.80	31.75	0.10	0.10	0.50	152.4	63.50	0.70	0.70	2.80
50.80	38.10	0.10	0.10	0.50	152.4	76.20	0.70	0.70	2.80
63.50	25.40	0.10	0.10	0.80	152.4	101.6	0.70	0.70	2.80
63.50	38.10	0.10	0.10	0.80	152.4	127.0	0.70	0.70	2.80
63.50	50.80	0.10	0.10	0.80	203.2	101.6	1.60	1.60	3.50
76.20	25.40	0.25	0.25	1.10	203.2	127.0	1.60	1.60	3.50
76.20	31.75	0.25	0.25	1.10	203.2	152.4	*	*	*
76.20	38.10	0.25	0.25	1.10	254.0	203.2	*	*	

* Large size reducing fittings stocked in 2.0mm wall thickness.

- Specification: AS 1528.3.
- Reducers and tees have no extended leg.



Stainless Steel Plain Tube Clamps

(mm)	25.40	31.75	38.10	50.80	63.50	76.20	88.90	101.6	127.0	152.4	203.2
(inches)	1	1¼	1½	2	2½	3	3½	4	5	6	8

Stainless Steel Feet and Plastic Inserts

- Plastic end inserts to suit square tube 25.40, 31.75, 38.10mm A/F.
- Stainless steel feet machine adjust tread with base 50mm or 63.5mm.
- Clamps and feet are grade 304 as standard.

BSM Unions

British Standard Milk (BSM) stainless steel unions were designed specifically for tube installation in the dairy industry, but they are now commonly used in food and beverage processing and the pharmaceutical industries where crevice-free hygienic conditions are required. A commonly used term is 'CIP' which comes from the phrase **Clean In Place**

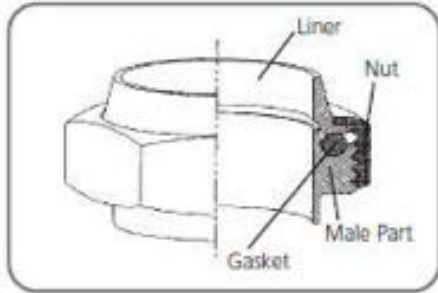

RJT (Ring Joint Type) – often referred to as a standard union comprises an 'O' ring style gasket. This leaves a small crevice internally where the liner and male part of the union overlap, this is not suitable for permanent CIP.

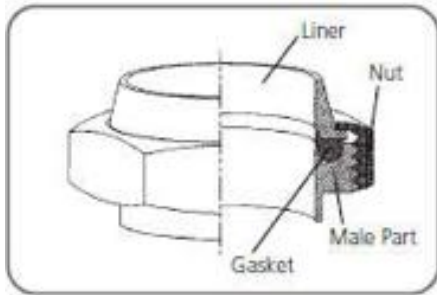

CIP (Australian style) – developed from an RJT union, features a shaped gasket completely filling the crevice between the liner and male part and allows a small lip to give a flush finish on the ID of the fitting. This gives the desirable characteristics for CIP installation.

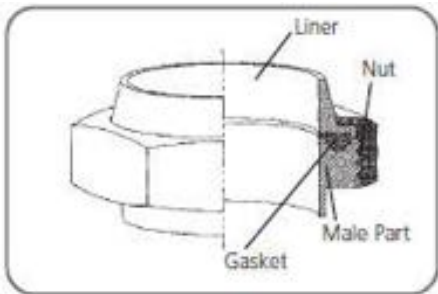

CIPFF – the FF stands for 'Flat Face' and refers to a BSM modified union supporting CIP installations and also enabling easy disassembly from process lines – once the nut is undone the union and attached tube line can be slid sideways.

Like the Australian style CIP union the gasket completely fills the crevice between the liner and male part to give a flush finish on the ID of the fitting. The liner and male parts of this union have been modified to create a flat face style sealed with a flat face gasket. A flat faced liner and male part used in a CIPFF union are shaped differently to that used in an RJT or CIP union.

Note: Temperature rating of EPDM "E" gasket material is -51° to 148°C.

Specification: AS 1528.2

BSM Unions

Union (complete) RJT, CIP and CIPFF							
(mm)	25.40	38.10	50.80	63.50	76.20	101.6	152.4
(inches)	1	1½	2	2½	3	4	6
Weight (kg)	0.41	0.45	0.61	0.71	1.01	1.41	1.71

Liners – Grade 316 RJT, CIP and CIPFF							
(mm)	25.40	38.10	50.80	63.50	76.20	101.6	152.4
(inches)	1	1½	2	2½	3	4	6
Weight (kg)	0.10	0.10	0.15	0.20	0.30	0.40	0.50

Male parts – Grade 316 RJT, CIP and CIPFF							
(mm)	25.40	38.10	50.80	63.50	76.20	101.6	152.4
(inches)	1	1½	2	2½	3	4	6
Weight (kg)	0.10	0.10	0.15	0.20	0.30	0.40	0.50

Gaskets – EPDM rubber – RJT, CIP and CIPFF							
(mm)	25.40	38.10	50.80	63.50	76.20	101.6	152.4
(inches)	1	1½	2	2½	3	4	6
Weight (kg)	0.01	0.01	0.01	0.01	0.01	0.01	0.01

Blank caps – Grade 316							
(mm)	25.40	38.10	50.80	63.50	76.20	101.6	152.4
(inches)	1	1½	2	2½	3	4	6
Weight (kg)	0.10	0.10	0.20	0.25	0.30	0.40	0.60

Blank nuts – Grade 304							
(mm)	25.40	38.10	50.80	63.50	76.20	101.6	152.4
(inches)	1	1½	2	2½	3	4	6
Weight (kg)	0.20	0.20	0.30	0.30	0.40	0.60	0.70

Hex nut – Grade 304							
(mm)	25.40	38.10	50.80	63.50	76.20	101.6	152.4
(inches)	1	1½	2	2½	3	4	6
Weight (kg)	0.20	0.20	0.30	0.30	0.40	0.60	0.70

A range of spanners and valves (ball and butterfly) is also available to match nominal tube dimensions.

Tri-clamp Stainless Steel Tube Fittings

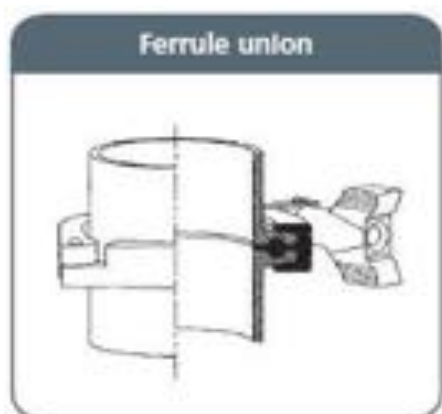

A tri-clamp is used to eliminate the need for a threaded joining system, employing a hinged clamp instead. The joint is common in CIP installation where the seal fills the crevice completely.

A range of spanners and valves (ball and butterfly) is also available to match nominal tube dimensions.

Specification: AS 1528.4

Tri-clamp Unions Complete							
(mm)	25.40	38.10	50.80	63.50	76.20	101.6	152.4
(inches)	1	1½	2	2½	3	4	6
Weight (kg)	0.4	0.4	0.7	1.1	1.1	1.5	2.4

Tri-clamp Ferrule – 316							
(mm)	25.40	38.10	50.80	63.50	76.20	101.6	152.4
(inches)	1	1½	2	2½	3	4	6
Weight (kg)	0.1	0.1	0.2	0.3	0.3	0.4	0.7

Tri-clamp Gaskets – EPDM rubber							
(mm)	25.40	38.10	50.80	63.50	76.20	101.6	152.4
(inches)	1	1½	2	2½	3	4	6
Weight (kg)	0.01	0.01	0.01	0.01	0.01	0.01	0.01

Tri-clamp Clamp - 316							
(mm)	25.40	38.10	50.80	63.50	76.20	101.6	152.4
(inches)	1	1½	2	2½	3	4	6
Weight (kg)	0.2	0.2	0.3	0.5	0.5	0.7	1.0

Tri-clamp Cap - 316						
(mm)	25.40	38.10	50.80	63.50	76.20	101.6
(inches)	1	1½	2	2½	3	4
Weight (kg)	0.1	0.1	0.2	0.25	0.3	0.40

Note: Temperature rating of EPDM “E” gasket material is -51° to +148°C

Carbon Steel Pipe, Fittings and Flanges



5 Carbon Steel Pipe, Fittings and Flanges



Carbon Steel Pipe Fittings and Flanges



Specifications – Carbon Steel Pipe, Buttwelding Fittings & Flanges

Linepipe	
Specification	ASTM A53/A53M
Dimensions	ASME B36.10M
Product	Welded and Seamless Steel Pipe
Grades	A, B
Specification	ASTM A106/A106M
Dimensions	ASME B36.10M
Product	Seamless Carbon Steel Pipe for High Temperature Service
Grades	A, B, C
Specification	ASTM A335/A335M
Dimensions	ASME B36.10M
Product	Seamless Ferritic Alloy Steel Pipe for High Temperature Service
Grades	Refer Standard for grades
Specification	ASTM A333/A333M
Dimensions	ASME B36.10M
Product	Seamless & Welded Carbon and Alloy Steel Pipe for Low Temperature Services
Grades	Refer Standard for grades
Specification	API 5L/ISO 3183
Dimensions	ASME B36.10M, API 5L
Product	Seamless & Welded Carbon Steel for Line Pipe
Grades	A, B, X42, X52, X60, Refer API 5L specification for others
Structural Steel	
Specification	AS/NZS 1163
Dimensions	AS/NZS 1163
Product	Structural Steel Hollow Sections
Grade	C350L0, Refer standard for others

Buttwelding Fittings	
Specification	ASTM A234M Welded and Seamless Carbon and Alloy Steel Pipe Fittings for Moderate and High Temperature Service ASTM A420M Welded and Seamless Carbon and Alloy Steel Pipe Fittings for Low Temperature Service
Dimensions	ASME B16.9
Product	Elbows, Reducing Elbows, Returns, Tees, Crosses, Reducers, Stub Ends, Caps
Grade	ASTM A234M WPB, ASTM A420M WPL6. Refer standard for others

Flanges	
Specification	ASTM A105M Carbon Steel Forgings for Piping Applications
Dimensions	ASME B16.5
Product	Weld Neck, Slip-on, Blind Flanges. Others refer to the specification.
Face	Plain, Raised Face
Bore	Pipe Schedule
Class	150, 300, 400, 600, 900, 1500, 2500 (to 600mm only)
Grade	Carbon Steel
Specification	AS 2129 Flanges for Pipes, Valves and Fittings
Dimensions	AS 2129 "Table" flanges pressure – temperature ratings, materials and dimensions
Application	Slip-on, Blind "Table" Flanges
Face	Plain
Bore	To suit Pipe & Tube OD
Table	D, E, F and H

Standard Atlas Steels stocks of carbon steel pipe comply with:

Welded (ERW)

ASTM A53M grade B
 API 5L grade X42, PSL1 or PSL2
 AS/NZS 1163 C350L0

Seamless

ASTM A106M grade B
 ASME SA106M grade B
 API 5L grade B and grade X42, PSL1 or PSL2

Carbon Steel Pipe – Dimensions

Nominal size	OD mm	Welded & Seamless Carbon Steel Pipe to ASME B36.10M All dimensions are in mm																Structural Steel Hollow Sections to AS/NZ S1163 Grade C350L0									
		Schedule																Wall Thickness in mm									
DN	NPS	5	10	20	30	40	Std	60	80	XS	100	120	140	160	XXS	4.8	5.5	6.0	6.4	7.1	8.2	9.3	9.5	12.7			
6	1/8		1.24		1.45	1.73	1.73		2.41	2.41																	
8	3/8		1.65		1.85	2.24	2.24		3.02	3.02																	
10	1/2		1.65		1.85	2.31	2.31		3.20	3.20																	
15	3/4	1.65	2.11		2.41	2.77	2.77		3.73	3.73				4.78	7.47												
20	1	1.65	2.11		2.41	2.87	2.87		4.55	4.55				5.56	7.82												
25	1 1/4	1.65	2.77		2.90	3.38	3.38		4.85	4.85				6.35	9.09												
32	1 1/2	1.65	2.77		2.97	3.56	3.56		4.85	4.85				6.35	9.70												
40	2	1.65	2.77		3.18	3.68	3.68		5.08	5.08				7.14	10.15												
50	2 1/2	1.65	2.77		3.18	3.91	3.91		5.54	5.54				8.74	11.07												
65	3	2.11	3.05		4.78	5.16	5.16		7.01	7.01				9.53	14.02												
80	3 1/2	2.11	3.05		4.78	5.49	5.49		7.62	7.62				11.13	15.24	✓											
90	4	2.11	3.05		4.78	5.74	5.74		8.08	8.08																	
100	4 1/2	2.11	3.05		4.78	6.02	6.02		8.56	8.56		11.13		13.49	17.12	✓											
125	5	2.77	3.40			6.55	6.55		9.53	9.53		12.70		15.88	19.05												
150	6	2.77	3.40			7.11	7.11		10.97	10.97		14.27		18.26	21.95	✓											
200	8	2.77	3.76	6.35	7.04	8.18	8.18	10.31	12.70	12.70	15.09	18.26	20.62	23.01	22.23	✓									✓		
250	10	3.40	4.19	6.35	7.80	9.27	9.27	12.70	15.09	12.70	18.26	21.44	25.40	28.58	25.40	✓									✓		
300	12	3.96	4.57	6.35	8.38	10.31	9.53	14.27	17.48	12.70	21.44	25.40	28.58	33.32	25.40										✓		
350	14	3.96	6.35	7.92	9.53	11.13	9.53	15.09	19.05	12.70	23.83	27.79	31.75	36.71											✓		
400	16	4.19	6.35	7.92	9.53	12.70	9.53	16.66	21.44	12.70	26.19	30.96	36.53	40.49											✓		
450	18	4.57	6.35	7.92	11.13	14.27	9.53	19.05	23.83	12.70	29.36	34.93	39.67	45.24											✓		
500	20	4.78	6.35	9.53	12.70	15.09	9.53	20.62	26.19	12.70	32.54	38.10	44.45	50.01											✓		
550	22	4.78	6.35	9.53	12.70		9.53	22.23	28.58	12.70	34.93	41.28	47.63	53.98													
600	24	5.54	6.35	9.53	14.27	17.48	9.53	24.61	30.96	12.70	38.89	46.02	52.37	59.54													
650	26		7.92	12.70			9.53			12.70																	
700	28		7.92	12.70	15.88		9.53			12.70																	
750	30	6.35	7.92	12.70	15.88		9.53			12.70																	
800	32		7.92	12.70	15.88	17.48	9.53			12.70																	
850	34		7.92	12.70	15.88	17.48	9.53			12.70																	
900	36		7.92	12.70	15.88	19.05	9.53			12.70																	
950	38						9.53			12.70																	
1000	40						9.53			12.70																	
1050	42						9.53			12.70																	
1100	44						9.53			12.70																	
1150	46						9.53			12.70																	
1200	48						9.53			12.70																	

Note 1: For dimensional tolerances refer to ASTM A53M or A106M
This table shows common sizes. Other wall thicknesses and larger diameter pipes are available subject to enquiry. Refer to ASME B36.10M for possible sizes.

Carbon Steel Pipe – Weights

Nominal size	OD	Welded & Seamless Carbon Steel Pipe to ASME B36.10M																Structural Steel Hollow Sections to AS/NZS 1163 Grade C350 (kg/m)									
		Schedule																Wall Thickness in mm									
		5	10	15	20	30	40	50	60	80	90	105	120	140	160	200	4.0	5.0	6.0	7.1	8.2	9.3	9.5	12.7			
6	6.3		0.28			0.32	0.37	0.41		0.47	0.47																
8	8.6		0.49			0.54	0.63	0.63		0.80	0.80																
10	11.3		0.63			0.70	0.84	0.84		1.10	1.10																
15	16.0		1.00			1.12	1.27	1.27		1.62	1.62				1.96	2.56											
20	21.3		1.28			1.44	1.69	1.69		2.20	2.20				2.90	3.64											
25	26.7		2.00			2.18	2.50	2.50		3.24	3.24				4.24	5.45											
30	32.5		2.69			2.87	3.39	3.39		4.47	4.47				5.81	7.77											
40	42.7		3.11			3.53	4.09	4.09		5.41	5.41				7.26	9.56											
50	54.0		3.93			4.48	5.44	5.44		7.48	7.48				11.11	13.44											
60	63.5		5.26			6.04	6.63	6.63		11.41	11.41				14.62	20.38											
80	89.1		6.45			9.92	11.29	11.29		15.27	15.27				21.36	27.68											
90	101.6		7.41			11.41	13.67	13.67		18.64	18.64																
100	114.3		8.37			12.91	16.06	16.06		22.32	22.32		26.32		33.64	41.63											
125	141.3		11.06				21.77	21.77		30.67	30.67		40.26		49.12	67.43											
150	168.3		13.63				28.26	28.26		42.56	42.56		54.21		67.57	79.22											
200	219.1		19.97			33.32	42.56	42.56		63.09	64.64		76.92		100.88	111.27											
250	273.0		27.76			41.76	51.61	51.61		81.63	85.98		114.71		156.30	172.27											
300	323.8		36.00			49.73	65.20	65.20		99.73	108.96		139.91		188.87	208.14											
350	366.6		44.69			61.33	84.55	84.55		126.71	158.10		194.96		253.59	281.31											
400	406.4		52.64			77.63	107.27	107.27		160.12	203.63		245.96		333.19	369.38											
450	451.7		60.77			92.28	130.80	130.80		206.34	264.56		309.62		408.26	469.37											
500	500.0		69.55			108.12	153.42	153.42		247.63	311.17		381.63		441.69	504.65											
600	600.0		86.54			131.00				329.13	404.26		481.42		527.02	600.63											
800	800.0		141.42			209.64	266.41	266.41		442.08	547.71		648.03		720.15	808.22											
1000	1000.0		202.72							632.87			802.72														
1200	1200.0		248.69							779.23			982.72														
1400	1400.0		294.67							932.18			1179.23														
1600	1600.0		342.15							1092.82			1382.15														
1800	1800.0		394.50							1262.82			1602.15														
2000	2000.0		449.42							1442.15			1842.15														
2200	2200.0		504.24							1632.15			2102.15														
2400	2400.0		564.11							1832.15			2382.15														
2600	2600.0		624.11							2042.15			2682.15														
2800	2800.0		684.11							2262.15			3002.15														
3000	3000.0		744.11							2492.15			3342.15														
3200	3200.0		804.11							2732.15			3702.15														
3400	3400.0		864.11							2982.15			4082.15														
3600	3600.0		924.11							3242.15			4482.15														
3800	3800.0		984.11							3512.15			4902.15														
4000	4000.0		1044.11							3792.15			5342.15														
4200	4200.0		1104.11							4082.15			5802.15														
4400	4400.0		1164.11							4382.15			6282.15														
4600	4600.0		1224.11							4692.15			6782.15														
4800	4800.0		1284.11							5012.15			7302.15														
5000	5000.0		1344.11							5342.15			7842.15														

Note 1: All weights are theoretical and approximate.
 Note 2: Formula for circular steel pipe kilogrammetre M = (D-t) x t x 0.02466
 This table shows common sizes. Other wall thicknesses and larger diameter pipes are available subject to enquiry. Refer to ASME B36.10M for possible sizes.

Carbon Steel ButtWelding Fittings – Dimensions

ButtWelding Fittings to a SME B16.9

Nominal size		OD		Elbows			Returns			Caps		Reducers Note 1		Stub ends						
DN	NPS	D	A	B	A	90 deg	45 deg	90 deg	Long	Short	O	K	E	H	F	Long	Short	Radius of Fillet	R	G
15	½	21.3	38	16					76	48			25		76	51	3	35		
20	¾	26.7	38	19					76	51			25	38	76	51	3	43		
25	1	33.4	38	22	25				76	56	51	41	38	51	102	51	3	51		
32	1¼	42.2	48	25	32				95	70	64	52	38	51	102	51	5	64		
40	1½	48.3	57	29	38				114	83	76	62	38	64	102	51	6	73		
50	2	60.3	76	35	51				152	106	102	81	38	76	152	64	8	92		
65	2½	73.0	95	44	64				190	132	127	100	38	89	152	64	8	106		
80	3	88.9	114	51	76				229	159	152	121	51	89	152	64	10	127		
90	3½	101.6	133	57	89				267	184	178	140	64	102	152	76	11	140		
100	4	114.3	152	64	102				305	210	203	159	64	102	152	76	11	157		
125	5	141.3	190	79	127				381	262	254	197	76	127	203	76	13	185		
150	6	168.3	229	95	152				457	313	305	237	89	140	203	89	13	218		
200	8	219.1	305	127	203				610	414	406	313	102	152	203	102	13	270		
250	10	273.0	381	159	254				762	518	508	391	127	178	254	127	13	324		
300	12	323.8	457	190	305				914	619	610	467	152	203	254	152	13	381		
350	14	355.6	533	222	356				1067	711	711	533	165	330	305	152	13	413		
400	16	406.4	610	254	406				1219	813	813	610	178	356	305	152	13	470		
450	18	457	686	286	457				1372	914	914	686	203	381	305	152	13	533		
500	20	508	762	318	508				1524	1016	1016	762	229	508	305	152	13	584		
550	22	559	838	343	559				1676	1118	1118	838	254	508	305	152	13	641		
600	24	610	914	381	610				1829	1219	1219	914	267	508	305	152	13	692		
650	26	660	991	405									267	610						
700	28	711	1067	438									267	610						
750	30	762	1143	470									267	610						
800	32	813	1219	502									267	610						
850	34	864	1295	533									267	610						
900	36	914	1372	565									267	610						
950	38	965	1448	600									305	610						
1000	40	1016	1524	632									305	610						
1050	42	1067	1600	660									305	610						
1100	44	1118	1676	695									343	610						
1150	46	1168	1753	727									343	711						
1200	48	1219	1829	759									343	711						

Note 1: Reducer dimension "H" is based on large end nominal size

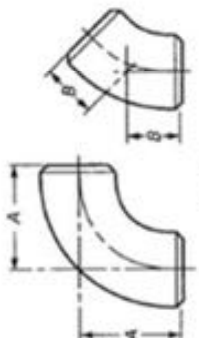

ELBOW



RETURN



CAP

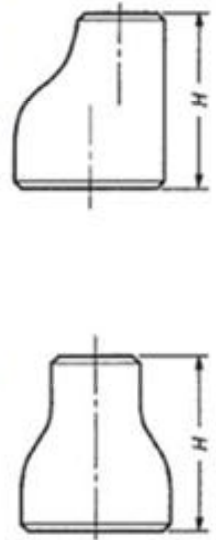

REDUCER

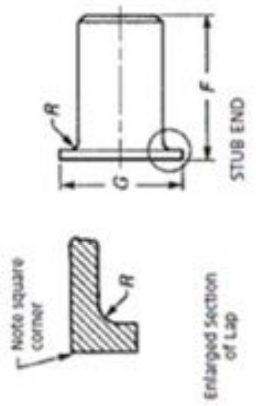

STUB END

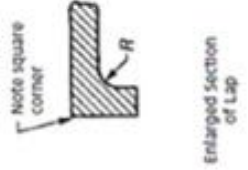

Enlarged section of Lap

Carbon Steel Buttwelding Fittings – Weight

Buttwelding Fittings (kg per unit)												
Standard Weight												
Nominal size		OD	Elbows			Returns		Caps	Reducers	Stub Ends		Tees
			Long		Short	Long	Short			MSS	ASME	
DN	NPS	mm	90 deg	45 deg	90 deg							
15	½	21.3	0.08	0.04		0.16		0.04		0.12	0.14	0.09
20	¾	26.7	0.11	0.06		0.21		0.05	0.06	0.15	0.18	0.13
25	1	33.4	0.16	0.08	0.11	0.31	0.21	0.11	0.12	0.19	0.30	0.25
32	1¼	42.2	0.26	0.13	0.18	0.52	0.35	0.14	0.16	0.26	0.41	0.43
40	1½	48.3	0.37	0.19	0.25	0.74	0.49	0.17	0.25	0.38	0.55	0.61
50	2	60.3	0.66	0.33	0.44	1.30	0.87	0.24	0.38	0.54	0.99	0.88
65	2½	73.0	1.29	0.69	0.91	2.73	1.82	0.42	0.73	0.8	1.56	1.74
80	3	88.9	2.04	1.02	1.36	4.07	2.71	0.67	0.94	1.13	2.13	2.41
90	3½	101.6	2.94	1.47	1.97	5.65	3.77	0.92	1.19	1.47	2.58	3.26
100	4	114.3	3.84	1.92	2.56	7.67	5.11	1.17	1.45	1.81	3.04	4.12
125	5	141.3	6.48	3.24	4.32	13.0	8.64	1.9	2.50	2.53	5.3	6.54
150	6	168.3	9.94	4.97	6.63	19.9	13.3	2.83	3.60	3.73	6.89	9.58
200	8	219.1	20.1	10.1	13.4	40.3	26.8	5.11	5.70	5.89	10.4	17.9
250	10	273.0	35.4	17.7	23.6	70.8	47.2	8.92	9.60	10.4	18.1	30.4
300	12	323.8	52.0	26.0	34.6	112	71.9	13.1	13.6	14.9	22.2	43.6
350	14	355.6	67.9	34.0	45.3			15.9	25.4	15.5	28.3	53.5
400	16	406.4	89.0	44.5	59.1			20.0	31.0	18.0	32.7	66.1
450	18	457	113	56.5	75.3			25.5	37.8	21.0	37.5	83.9
500	20	508	140	70.0	93.1			31.8	55.4	23.3	41.7	104
550	22	559	169	84.5	113			38.8	62.4	25.8	46.3	126
600	24	610	202	101	135			45.1	68.4	28.4	50.5	139
650	26	660	237	119	158			50.5	89.4			176
700	28	711	276	138	184			56.2	96.6			198
750	30	762	316	158	211			62.1	104			228
800	32	813	361	180	241			68.4	111			259
850	34	864	406	204	272			75.4	116			295
900	36	914	457	228	304			81.9	125			331
950	38	965	510	255	340			94.7	133			370
1000	40	1016	565	282	377			102	140			411
1050	42	1067	622	311	416			110	147			422
1100	44	1118	684	342	456			126	155			475
1150	46	1168	748	374	499			134	189			521
1200	48	1219	814	407	543			143	197			569

Buttwelding Fittings (kg per unit)												
XS												
Nominal size		OD	Elbows			Returns		Caps	Reducers	Stub Ends		Tees
			Long		Short	Long	Short			MSS	ASME	
DN	NPS	mm	90 deg	45 deg	90 deg							
15	½	21.3	0.10	0.05		0.20		0.05		0.13	0.12	0.11
20	¾	26.7	0.14	0.70		0.21		0.07	0.08	0.17	0.2	0.17
25	1	33.4	0.20	0.10	0.14	0.41	0.26	0.15	0.15	0.24	0.38	0.32
32	1¼	42.2	0.35	0.18	0.23	0.70	0.46	0.20	0.21	0.35	0.55	0.56
40	1½	48.3	0.50	0.25	0.33	1.02	0.66	0.24	0.33	0.46	0.68	0.81
50	2	60.3	0.90	0.45	0.6	1.88	1.19	0.33	0.51	0.74	1.36	1.20
65	2½	73.0	1.79	0.90	1.19	3.56	2.38	0.57	0.95	1.06	2.08	2.28
80	3	88.9	2.74	1.37	1.83	5.74	3.65	0.92	1.25	1.51	2.84	3.25
90	3½	101.6	4.05	2.02	2.07	12.7	5.21	1.30	1.64	2.01	3.51	4.51
100	4	114.3	5.36	2.68	3.58	15.7	7.15	1.68	2.02	2.52	4.23	5.77
125	5	141.3	9.13	4.57	6.09	19.3	12.2	2.73	3.52	3.60	7.52	9.2
150	6	168.3	15.0	7.50	10.0	31.9	20.0	4.38	5.38	5.57	10.4	14.5
200	8	219.1	30.5	15.3	20.3	64.3	40.7	7.91	8.63	10.1	15.9	27.1
250	10	273.0	47.7	23.9	31.8	99.6	74.9	12.2	12.9	13.9	24.3	41.0
300	12	323.8	68.7	34.4	45.8	144.9	94.9	17.4	18.0	19.9	29.8	57.7
350	14	355.6	89.9	15.0	60.0			21.2	33.6	21	38	70.9
400	16	406.4	118	59.0	78.3			26.7	41.1	24	44	87.7
450	18	457	150	75.5	100			34.1	50.1	28	50	111
500	20	508	186	93	124			42.5	74.9	31	56	138
550	22	559	225	113	150			51.7	82.9	33	61	167
600	24	610	268	134	179			60.1	91	37	67	186
650	26	660	315	158	210			67.3	119			234
700	28	711	367	184	245			74.9	129			264
750	30	762	421	211	281			82.8	138			304
800	32	813	480	240	320			91.2	148			347
850	34	864	543	272	362			100	158			393
900	36	914	608	304	405			109	167			441
950	38	965	679	339	453			126	177			493
1000	40	1016	753	376	502			137	187			547
1050	42	1067	828	414	554			147	196			562
1100	44	1118	912	456	608			167	206			633
1150	46	1168	997	498	665			179	252			695
1200	48	1219	1085	542	724			191	263			759

Buttwelding Fittings (kg per unit)								
Sch 160								
Nominal size		OD	Elbows			Caps	Reducers	Tees
			Long		Short			
DN	NPS	mm	90 deg	45 deg	90 deg			
15	½	21.3	0.12			0.06		0.12
20	¾	26.7	0.13			0.09		0.21
25	1	33.4	0.25	0.13	0.17	0.20	0.19	0.41
32	1¼	42.2	0.42	0.21	0.28	0.25	0.25	0.69
40	1½	48.3	0.65	0.33	0.43	0.35	0.43	1.07
50	2	60.3	1.33	0.67	0.89	0.54	0.75	1.78
65	2½	73.0	2.33	1.17	1.49	0.77	1.20	2.86
80	3	88.9	3.83	1.92	2.55	1.40	1.71	4.55
90	3½	101.6	5.92	2.96	3.95	2.10	2.35	6.52
100	4	114.3	8.02	4.01	5.35	2.76	3.00	8.50
125	5	141.3	14.7	7.35	9.79	4.85	5.59	14.8
150	6	168.3	24.2	12.1	16.2	7.81	8.63	23.3
200	8	219.1	53.2	26.6	35.5	15.2	15.0	47.2
250	10	273.0	103	51.5	68.6	28.9	27.5	88.0
300	12	323.8	171	85.5	114	47.7	44.6	143
350	14	355.6	236	118	158	61.2	88.5	186
400	16	406.4	350	175	234	92.8	121	260
450	18	457	495	247	330	131	165	356
500	20	508	676	338	451	179	233	502
550	22	559	886	443	591	219		657
600	24	610	1160	580	773	307		800
650	26	660						
700	28	711						
750	30	762						
800	32	813						
850	34	864						
900	36	914						
950	38	965						
1000	40	1016						
1050	42	1067						
1100	44	1118						
1150	46	1168						
1200	48	1219						

Carbon Steel ASME/ANSI Flanges – Dimensions & Weights

These diagrams relate to the tables of flange specified dimensions on the following pages.

The Notes shown on this page also relate to the tables on the following pages.

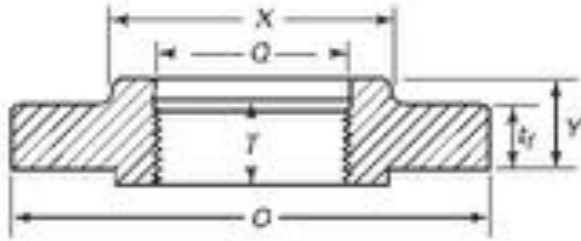

Threaded

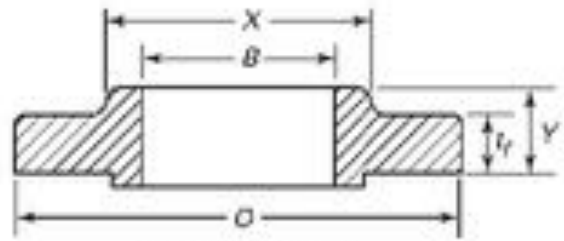

Slip-On Welding

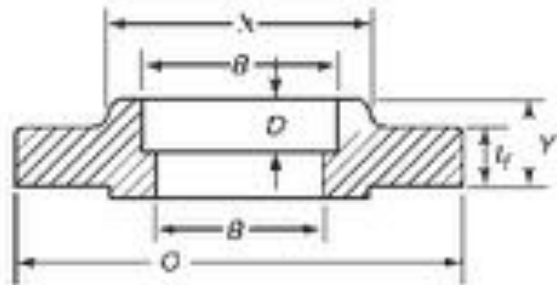

Socket Welding

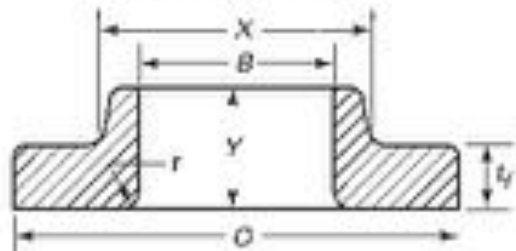

Lapped

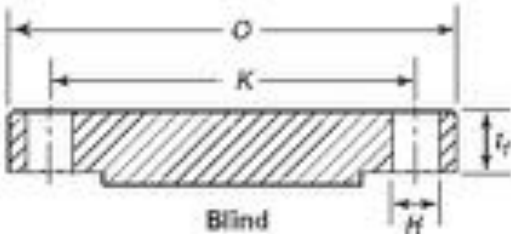

Blind

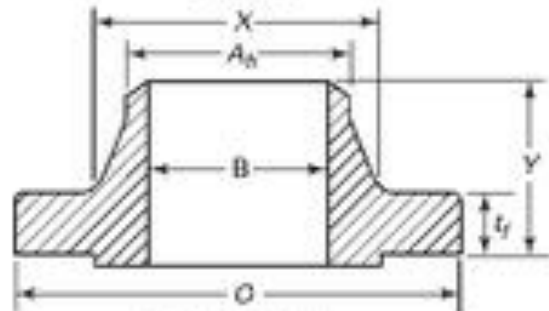

Welding Neck

Note 1: To be specified by purchase

Note 2: Flange weights are approximate

Note 3: Welding neck flange bore sizes listed are for sch 40S / Standard Wall pipe

Carbon Steel ASME/ANSI Flanges – Dimensions & Weights

Class 150 Flanges to ASME B16.5																	
Nominal Size		Dimensions													Flange Weight (kg)		
DN	NPS	Flange OD (mm) O	Thick-ness min (mm) t _f	Hub Diam. (mm) X	Hub Diam. Welding Neck (mm) A _n	Length Thru Hub		Bore		Bolt Drilling					Slip-on	Welding Neck	Blind
						Slip-on/Socket Welding (mm) Y	Welding Neck (mm) Y	Slip-on/Socket Welding min (mm) B	Welding Neck / Socket Welding (mm) B	Circle Diam. (mm) K	Hole Diam. (mm) H	Bolts (No.)	RF Stud Bolt Length (mm)	RF Machine Bolt Length (mm)			
15	½	90	9.6	30	21.3	14	46	22.2	15.8	60.3	15.9	4	55	50	0.4	0.5	0.4
20	¾	100	11.2	38	26.7	14	51	27.7	20.9	69.9	15.9	4	65	50	0.6	0.7	0.6
25	1	110	12.7	49	33.4	16	54	34.5	26.6	79.4	15.9	4	65	55	0.8	1.0	0.9
32	1 ¼	115	14.3	59	42.2	19	56	43.2	35.1	88.9	15.9	4	70	55	1.0	1.3	1.2
40	1 ½	125	15.9	65	48.3	21	60	49.5	40.9	98.4	15.9	4	70	65	1.3	1.7	1.5
50	2	150	17.5	78	60.3	24	62	61.9	52.5	120.7	19.1	4	85	70	2.1	2.6	2.4
65	2 ½	180	20.7	90	73.0	27	68	76.6	62.7	139.7	19.1	4	90	75	3.3	4.1	3.9
80	3	190	22.3	108	88.9	29	68	90.7	77.9	152.4	19.1	4	90	75	3.9	4.9	4.9
90	3 ½	215	22.3	122	101.6	30	70	103.4	90.1	177.8	19.1	8	90	75	4.8	6.1	6.2
100	4	230	22.3	135	114.3	32	75	116.1	102.3	190.5	19.1	8	90	75	5.3	6.8	7.0
125	5	255	22.3	164	141.3	35	87	143.8	128.2	215.9	22.2	8	95	85	6.1	8.6	8.5
100	4	230	22.3	135	114.3	32	75	116.1	102.3	190.5	19.1	8	90	75	5.3	6.8	7.0
125	5	255	22.3	164	141.3	35	87	143.8	128.2	215.9	22.2	8	95	85	6.1	8.6	8.6
150	6	280	23.9	192	168.3	38	87	170.7	154.1	241.3	22.2	8	100	85	7.5	11	11
200	8	345	27.0	246	219.1	43	100	221.5	202.7	298.5	22.2	8	110	90	12	18	20
250	10	405	28.6	305	273.0	48	100	276.2	254.6	362.0	25.4	12	115	100	17	24	29
300	12	485	30.2	365	323.8	54	113	327.0	304.8	431.8	25.4	12	120	100	26	37	43
350	14	535	33.4	400	355.6	56	125	359.2	Note (1)	476.3	28.6	12	135	115	35	48	58
400	16	595	35.0	457	406.4	62	125	410.5	Note (1)	539.8	28.6	16	135	115	45	61	76
450	18	635	38.1	505	457.0	67	138	461.8	Note (1)	577.9	31.8	16	145	125	49	68	94
500	20	700	41.3	559	508.0	71	143	513.1	Note (1)	635.0	31.8	20	160	140	62	85	122
600	24	815	46.1	663	610.0	81	151	616.0	Note (1)	749.3	34.9	20	170	150	87	115	186

Class 300 Flanges to ASME B16.5																	
Nominal Size		Dimensions													Flange Weight (kg)		
DN	NPS	Flange OD (mm) O	Thick-ness min (mm) t _f	Hub Diam. (mm) X	Hub Diam. Welding Neck (mm) A _n	Length Thru Hub		Bore		Bolt Drilling					Slip-on	Welding Neck	Blind
						Slip-on/Socket Welding (mm) Y	Welding Neck (mm) Y	Slip-on/Socket Welding min (mm) B	Welding Neck / Socket Welding (mm) B	Circle Diam. (mm) K	Hole Diam. (mm) H	Bolts (No.)	RF Stud Bolt Length (mm)	RF Machine Bolt Length (mm)			
15	½	95	12.7	38	21.3	21	51	22.2	15.8	66.7	15.9	4	65	55	0.6	0.8	0.6
20	¾	115	14.3	48	26.7	24	56	27.7	20.9	82.6	19.1	4	75	65	1.2	1.3	1.2
25	1	125	15.9	54	33.4	25	60	34.5	26.6	88.9	19.1	4	75	65	1.4	1.6	1.4
32	1 ¼	135	17.5	64	42.2	25	64	43.2	35.1	98.4	19.1	4	85	70	1.7	2.1	1.8
40	1 ½	155	19.1	70	48.3	29	67	49.5	40.9	114.3	22.2	4	90	75	2.6	3.1	2.7
50	2	165	20.7	84	60.3	32	68	61.9	52.5	127.0	19.1	8	90	75	2.9	3.4	3.1
65	2 ½	190	23.9	100	73.0	37	75	74.6	62.7	149.2	22.2	8	100	85	4.5	5.3	4.8
80	3	210	27.0	117	88.9	41	78	90.7	77.9	168.3	22.2	8	110	90	6.2	7.3	6.8
90	3 ½	230	28.6	133	101.6	43	79	103.4	90.1	184.2	22.2	8	110	95		8.2	9.5
100	4	255	30.2	146	114.3	46	84	116.1	102.3	200.0	22.2	8	115	95		11	12
125	5	280	33.4	178	141.3	49	97	143.8	128.2	235.0	22.2	8	120	110		15	16
150	6	320	35.0	206	168.3	51	97	170.7	154.1	269.9	22.2	12	120	110		20	21
200	8	380	39.7	260	219.1	60	110	221.5	202.7	330.2	25.4	12	140	120		30	35
250	10	445	46.1	321	273.0	65	116	276.2	254.6	387.4	28.6	16	160	140		44	55
300	12	520	49.3	375	323.8	71	129	327.0	304.8	450.8	31.8	16	170	145		64	79
350	14	585	52.4	425	355.6	75	141	359.2	Note (1)	514.4	31.8	20	180	160		88	107
400	16	650	55.6	483	406.4	81	144	410.5	Note (1)	571.5	34.9	20	190	165		113	139
450	18	710	58.8	533	457.0	87	157	461.8	Note (1)	628.6	34.9	24	195	170		138	177
500	20	775	62.0	587	508.0	94	160	513.1	Note (1)	685.8	34.9	24	205	185		167	223
600	24	915	68.3	702	610.0	105	167	616.0	Note (1)	812.8	41.3	24	230	205		235	342

These flanges are available in a very wide range of sizes, ratings and types in 304/304L and 316/316L. Other grades such as 2205 are available subject to enquiry.

Carbon Steel ASME/ANSI Flanges – Dimensions & Weights

Class 600 Flanges to ASME B16.5																
Nominal Size		Dimensions												Flange Weight (kg)		
DN	NPS	Flange OD (mm) O	Thick-ness min (mm) t _t	Hub Diam. (mm) X	Hub Diam. Welding Neck (mm) A _h	Length Thru Hub		Bore		Bolt Drilling				Slip-on	Welding Neck	Blind
						Slip-on/Socket Welding (mm) Y	Welding Neck (mm) Y	Slip-on/Socket Welding min (mm) B	Welding Neck / Socket Welding (mm) B	Circle Diam. (mm) K	Hole Diam. (mm) H	Bolts (No.)	RF Stud Bolt Length (mm)			
15	½	95	14.3	38	21.3	22	52	22.2	Note (1)	66.7	15.9	4	75	0.9	0.9	0.9
20	¾	115	15.9	48	26.7	25	57	27.7	Note (1)	82.6	19.1	4	90	1.4	1.6	1.4
25	1	125	17.5	54	33.4	27	62	34.5	Note (1)	88.9	19.1	4	90	1.8	1.9	1.8
32	1 ¼	135	20.7	64	42.2	29	67	43.2	Note (1)	98.4	19.1	4	95	2.6	2.5	2.4
40	1 ½	155	22.3	70	48.3	32	70	49.5	Note (1)	114.3	22.2	4	110	3.2	3.6	3.4
50	2	165	25.4	84	60.3	37	73	61.9	Note (1)	127.0	19.1	8	110	3.9	4.5	4.4
65	2 ½	190	28.6	100	73.0	41	79	74.6	Note (1)	149.2	22.2	8	120	5.9	6.4	6.8
80	3	210	31.8	117	88.9	46	83	90.7	Note (1)	168.3	22.2	8	125	7.4	8.1	8.9
90	3 ½	230	35.0	133	101.6	49	86	103.4	Note (1)	184.	25.4	8	140		12	13
100	4	275	38.1	152	114.3	54	102	116.1	Note (1)	215.9	25.4	8	145		17	19
125	5	330	44.5	189	141.3	60	114	143.8	Note (1)	266.7	28.6	8	165		31	31
150	6	355	47.7	222	168.3	67	117	170.7	Note (1)	292.1	28.6	12	170		37	38
200	8	420	55.6	273	219.1	76	133	221.5	Note (1)	349.2	31.8	12	190		51	62
250	10	510	63.5	343	273.0	86	152	276.2	Note (1)	431.8	34.9	16	215		86	102
300	12	560	66.7	400	323.8	92	156	327.0	Note (1)	489.0	34.9	20	220		103	132
350	14	605	69.9	432	355.6	94	165	359.2	Note (1)	527.0	38.1	20	235		122	158
400	16	685	76.2	495	406.4	106	178	410.5	Note (1)	603.2	41.3	20	255		177	225
450	18	745	82.6	546	457.0	117	184	461.8	Note (1)	654.0	44.5	20	275		216	285
500	20	815	88.9	610	508.0	127	190	513.1	Note (1)	723.9	44.5	24	285		268	365
600	24	940	101.6	718	610.0	140	203	616.0	Note (1)	838.2	50.8	24	330		372	533

Class 900 Flanges to ASME B16.5																
Nominal Size		Dimensions												Flange Weight (kg)		
DN	NPS	Flange OD (mm) O	Thick-ness min (mm) t _t	Hub Diam. (mm) X	Hub Diam. Welding Neck (mm) A _h	Length Thru Hub		Bore		Bolt Drilling				Slip-on	Welding Neck	Blind
						Slip-on/Socket Welding (mm) Y	Welding Neck (mm) Y	Slip-on/Socket Welding min (mm) B	Welding Neck / Socket Welding (mm) B	Circle Diam. (mm) K	Hole Diam. (mm) H	Bolts (No.)	RF Stud Bolt Length (mm)			
15	½	120	22.3	38	21.3	32	60	22.2	Note (1)	82.6	22.2	4	110	1.8	2.1	1.9
20	¾	130	25.4	44	26.7	35	70	27.7	Note (1)	88.9	22.2	4	115	2.3	2.7	2.7
25	1	150	28.6	52	33.4	41	73	34.5	Note (1)	101.6	25.4	4	125	3.4	3.9	4.1
32	1 ¼	160	28.6	64	42.2	41	73	43.2	Note (1)	111.1	25.4	4	125	4.1	4.5	4.3
40	1 ½	180	31.8	70	48.3	44	83	49.5	Note (1)	123.8	28.6	4	140	5.5	5.9	5.9
50	2	215	38.1	105	60.3	57	102	61.9	Note (1)	165.1	25.4	8	145	11	11	11
65	2 ½	245	41.3	124	73.0	64	105	74.6	Note (1)	190.5	28.6	8	160	16	16	16
80	3	240	38.1	127	88.9	54	102	90.7	Note (1)	190.5	25.4	8	145	12	15	13
100	4	290	44.5	159	114.3	70	114	116.1	Note (1)	235.0	31.8	8	170	23	23	25
125	5	350	50.8	190	141.3	79	127	143.8	Note (1)	279.4	34.9	8	190	38	39	39
150	6	380	55.6	235	168.3	86	140	170.7	Note (1)	317.5	31.8	12	190	48	50	52
200	8	470	63.5	298	219.1	102	162	221.5	Note (1)	393.7	38.1	12	220	75	79	59
250	10	545	39.9	368	273.0	108	184	276.2	Note (1)	469.9	38.1	16	235	111	118	132
300	12	610	79.4	419	323.8	117	200	327.0	Note (1)	533.4	38.1	20	255	146	157	187
350	14	640	85.8	451	355.6	130	213	359.2	Note (1)	558.8	41.3	20	275	172	182	224
400	16	705	88.9	508	406.4	133	216	410.5	Note (1)	616.0	44.5	20	285	193	225	272
450	18	785	101.6	565	457.0	152	229	461.8	Note (1)	685.8	50.8	20	325	272	309	386
500	20	855	108.0	622	508.0	159	248	513.1	Note (1)	749.3	54.0	20	350	331	377	488
600	24	1040	139.7	749	610.0	203	292	616.0	Note (1)	901.7	66.7	20	440	632	685	905

These flanges are available in a very wide range of sizes, ratings and types in 304/304L and 316/316L. Other grades such as 2205 are available subject to enquiry.

Carbon Steel ASME/ANSI Flanges – Dimensions & Weights

Class 1500 Flanges to ASME B16.5																
Nominal Size		Dimensions												Flange Weight (kg)		
DN	NPS	Flange OD (mm) O	Thick-ness min (mm) t _r	Hub Diam. (mm) X	Hub Diam. Welding Neck (mm) A _n	Length Thru Hub		Bore		Bolt Drilling				Slip-on	Welding Neck	Blind
						Slip-on/Socket Welding (mm) Y	Welding Neck (mm) Y	Slip-on/Socket Welding min (mm) B	Welding Neck / Socket Welding (mm) B	Circle Diam. (mm) K	Hole Diam. (mm) H	Bolts (No.)	RF Stud Bolt Length (mm)			
15	½	120	22.3	38	21.3	32	60	22.2	Note (1)	82.6	22.2	4	110	1.8	2.1	1.9
20	¾	130	25.4	44	26.7	35	70	27.7	Note (1)	88.9	22.2	4	115	2.8	2.7	2.7
25	1	150	28.6	52	33.4	41	73	34.5	Note (1)	101.6	25.4	4	125	3.6	3.9	4.1
32	1 ¼	160	28.6	64	42.2	41	73	43.2	Note (1)	111.1	25.4	4	125	5.0	4.5	4.3
40	1 ½	180	31.8	70	48.3	44	83	49.5	Note (1)	123.8	28.6	4	140	6.8	5.9	5.9
50	2	215	38.1	105	60.3	57	102	61.9	Note (1)	165.1	25.4	8	145	11	11	11
65	2 ½	245	41.3	124	73.0	64	105	74.6	Note (1)	190.5	28.6	8	160	16	16	16
80	3	265	47.7	133	88.9		117		Note (1)	203.2	31.8	8	180		22	22
100	4	310	54.0	162	114.3		124		Note (1)	241.3	34.9	8	195		31	33
125	5	375	73.1	197	141.3		156		Note (1)	292.1	41.3	8	250		59	60
150	6	395	82.6	229	168.3		171		Note (1)	317.5	38.1	12	260		75	75
200	8	485	92.1	292	219.1		213		Note (1)	393.7	44.5	12	290		124	137
250	10	585	108.0	368	273.0		254		Note (1)	482.6	50.8	12	335		206	230
300	12	675	123.9	451	323.8		283		Note (1)	571.5	54.0	16	375		306	316
350	14	750	133.4	495	355.6		298		Note (1)	635.0	60.3	16	405		416	421
400	16	825	146.1	552	406.4		311		Note (1)	704.8	66.7	16	445		568	559
450	18	915	162.0	597	457.0		327		Note (1)	774.7	73.0	16	495		736	761
500	20	985	177.8	641	508.0		356		Note (1)	831.8	79.4	16	540		929	967
600	24	1170	203.2	762	610.0		406		Note (1)	990.6	92.1	16	615		1504	1568

Class 2500 Flanges to ASME B16.5																
Nominal Size		Dimensions												Flange Weight (kg)		
DN	NPS	Flange OD (mm) O	Thick-ness min (mm) t _r	Hub Diam. (mm) X	Hub Diam. Welding Neck (mm) A _n	Length Thru Hub		Bore		Bolt Drilling				Slip-on	Welding Neck	Blind
						Slip-on/Socket Welding (mm) Y	Welding Neck (mm) Y	Slip-on/Socket Welding min (mm) B	Welding Neck / Socket Welding (mm) B	Circle Diam. (mm) K	Hole Diam. (mm) H	Bolts (No.)	RF Stud Bolt Length (mm)			
15	½	135	30.2	43	21.3	40	73	22.9	Note (1)	88.9	22.2	4	120	3.0	3.2	3.2
20	¾	140	31.8	51	26.7	43	79	28.2	Note (1)	95.2	22.2	4	125	3.6	4.1	4.5
25	1	160	35.0	57	33.4	48	89	34.9	Note (1)	108.0	25.4	4	140	5.0	5.5	5.4
32	1 ¼	185	38.1	73	42.2	52	95	43.7	Note (1)	130.2	28.6	4	150	7.3	9.1	8.2
40	1 ½	205	44.5	79	48.3	60	111	50.0	Note (1)	146.0	31.8	4	170	10	11	10
50	2	235	50.9	95	60.3	70	127	62.5	Note (1)	171.4	28.6	8	180	17	19	18
65	2 ½	265	57.2	114	73.0	79	143	75.4	Note (1)	196.8	31.8	8	195	24	24	25
80	3	305	66.7	133	88.9	92	168	91.4	Note (1)	228.6	34.9	8	220	36	43	39
100	4	355	76.2	165	114.3	108	190	116.8	Note (1)	273.0	41.3	8	255	54	64	60
125	5	420	92.1	203	141.3	130	229	144.4	Note (1)	323.8	47.6	8	300	93	111	101
150	6	485	108.0	235	168.3	152	273	171.4	Note (1)	368.3	54.0	8	345	143	176	157
200	8	550	127.0	305	219.1	178	318	222.2	Note (1)	438.2	54.0	12	380	213	261	241
250	10	675	165.1	375	273.0	229	419	277.4	Note (1)	539.8	66.7	12	490	409	484	465
300	12	760	184.2	441	323.8	254	464	328.2	Note (1)	619.1	73.0	12	540	573	692	664

These flanges are available in a very wide range of sizes, ratings and types in 304/304L and 316/316L. Other grades such as 2205 are available subject to enquiry.

Carbon Steel Table Flanges – Dimensions & Weights

These diagrams relate to the tables of flange specified dimensions on the following pages. Refer note below regarding terminology of Table flange types.

Types of Table Flanges specified in AS 2129.

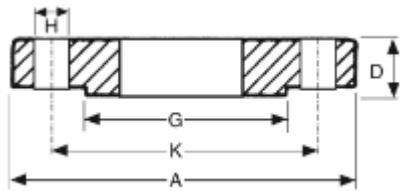
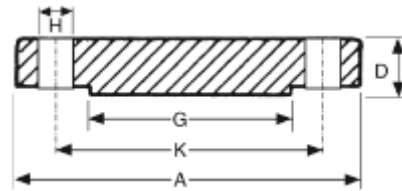
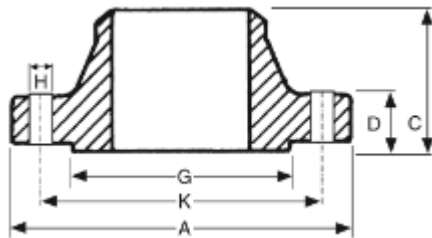

PLATE
"SLIP-ON WELDING"



BLIND
("BLANK")



WELDING NECK (WN)

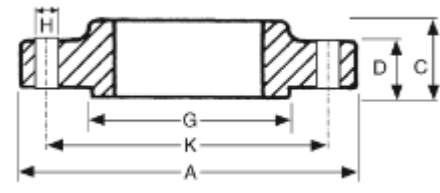

BOSS

Notes to these diagrams and the following tables of dimensions.

- Diagrams above show the optional Raised Face.
- Standard Atlas Steels Table Flange stock is Flat Faced.
- All weights are approximate
- A diametrical clearance of 4mm maximum applies to pipe or tube OD for plate flanges
- The flange thickness "D" dimension includes the raised face height, if a non-standard raised sealing face is present.
- Welding Neck bore is derived from the pipe schedule
- Atlas standard stock table flanges are plate and blind type. Note that AS2129 plate flanges are usually referred to by end users as "slip-on welding" flanges and this terminology is also used in Atlas product descriptions.
- PN16 "DIN" flanges to EN1092-1 and AS4087 waterworks flanges are also available subject to enquiry.

Carbon Steel Table Flanges – Dimensions & Weights

Nominal Size	Dimensions (mm)							Weight (kg)	
	DN	OD A	Thickness D	Raised Face Diam G	Drilling			Bolt Size & Thread	SOW
Bolt Circle Diam K					Bolt Hole Diam H	Number of Bolts			
15	95	*5	47	67	14	4	M12	0.6	0.6
20	100	*5	53	73	14	4	M12	0.7	0.7
25	115	*5	65	83	14	4	M12	0.9	1.0
32	120	*6	67	87	14	4	M12	0.9	1.1
40	135	*6	78	98	14	4	M12	1.2	1.4
50	150	*8	90	114	18	4	M16	1.4	1.7
65	165	*8	103	127	18	4	M16	1.6	2.1
80	185	*10	122	146	18	4	M16	2.0	2.7
90	205	*10	141	165	18	4	M16	2.2	3.2
100	215	*10	154	178	18	4	M16	2.5	3.6
125	255	13	186	210	18	8	M16	3.3	4.9
150	280	13	211	235	18	8	M16	4.0	6.1
200	335	13	268	292	18	8	M16	5.0	8.8
250	405	16	328	356	22	8	M20	8.7	15.8
300	455	19	378	406	22	12	M20	11.3	23.6
350	525	22	438	470	26	12	M24	19.6	38.6
400	580	22	489	521	26	12	M24	22.3	44.9
450	640	25	532	584	26	12	M24	29.0	63.0
500	705	29	609	641	26	16	M24	39.9	86.0
550	760	29	637	699	30	16	M27	50.0	107.0
600	825	32	720	756	30	16	M27	58.0	125.0
700	910	35	809	845	30	20	M27		
750	995	41	888	927	33	20	M30		
800	1060	41	942	984	36	20	M33		
850	1090	44	974	1016	36	20	M33		
900	1175	48	1050	1092	36	24	M33		
1000	1255	51	1133	1175	36	24	M33		
1200	1490	60	1368	1410	36	32	M33		

Nominal Size	Dimensions (mm)							Weight (kg)	
	DN	OD A	Thickness D	Raised Face Diam G	Drilling			Bolt Size & Thread	SOW
Bolt Circle Diam K					Bolt Hole Diam H	Number of Bolts			
15	95	*6	47	67	14	4	M12	0.6	0.7
20	100	*6	53	73	14	4	M12	0.7	0.8
25	115	*7	63	83	14	4	M12	0.9	1.0
32	120	*8	67	87	14	4	M12	1.0	1.1
40	135	*9	78	98	14	4	M12	1.2	1.4
50	150	*10	90	114	18	4	M16	1.4	1.7
65	165	*10	103	127	18	4	M16	1.6	2.1
80	185	*11	122	146	18	4	M16	2.0	2.7
90	205	12	141	165	18	8	M16		
100	215	13	154	178	18	8	M16	2.5	3.6
125	255	14	186	210	18	8	M16	3.7	5.5
150	280	17	207	235	22	8	M20	5.0	8.3
200	335	19	264	292	22	8	M20	7.1	12.9
250	405	22	328	356	22	12	M20	11.4	21.9
300	455	25	374	406	26	12	M24	15.1	31.8
350	525	29	438	470	26	12	M24	25.3	47.6
400	580	32	489	521	26	12	M24	31.3	66.0
450	640	35	552	584	26	16	M24	40.8	87.0
500	705	38	609	641	26	16	M24	53.0	114.0
550	760	44	663	699	30	16	M27		
600	825	48	717	756	33	16	M30	85.0	195.0
700	910	51	806	845	33	20	M30		
750	995	54	885	927	36	20	M33		
800	1060	54	942	984	36	20	M33		
850	1090	57	974	1016	36	20	M33		
900	1175	64	1050	1092	36	24	M33		
1000	1255	67	1130	1175	39	24	M36		
1200	1490	79	1365	1410	39	32	M36		

Carbon Steel Table Flanges – Dimensions & Weights

Nominal Size	Dimensions (mm)							Weight (kg)		
	DN	OD A	Thickness D	Raised Face Diam G	Drilling			Bolt Size & Thread	SOW	Blind
					Bolt Circle Diam. K	Bolt Hole Diam H	Number of Bolts			
15	95	10	47	67	14	4	M12	0.6	0.7	
20	100	10	53	73	14	4	M12	0.7	0.8	
25	120	10	63	87	18	4	M16	0.9	1.0	
32	135	13	74	98	18	4	M16	1.1	1.3	
40	140	13	81	105	18	4	M16	1.2	1.4	
50	165	16	103	127	18	4	M16	2.2	2.6	
65	185	16	122	146	18	4	M16	2.5	3.0	
80	205	16	141	165	18	8	M16	3.0	3.8	
90	215	19	154	178	18	8	M16			
100	230	19	167	191	18	8	M16	4.3	5.9	
125	280	22	207	235	22	8	M20	7.4	10.1	
150	305	22	232	260	22	12	M20	8.1	11.9	
200	370	35	296	324	22	12	M20	12.7	20.3	
250	430	29	349	381	26	12	M24	18.1	31.4	
300	490	32	406	438	26	16	M24	23.9	44.7	
350	550	35	459	495	30	16	M27	35.3	63.0	
400	610	41	516	552	30	20	M27	47.6	90.0	
450	675	44	571	610	33	20	M30	62.0	120.0	
500	735	51	634	673	33	24	M30	80.0	162.0	
550	785	54	685	724	33	24	M30			
600	850	57	739	781	36	24	M33	112.0		
700	935	60	815	857	36	24	M33			
750	1015	67	898	940	36	28	M33			
800	1060	68	942	984	36	28	M33			
850	1090	70	974	1016	36	32	M33			
900	1185	76	1060	1105	39	32	M36			
1000	1275	83	1149	1194	39	36	M36			
1200	1530	95	1385	1441	42	40	M39			

Nominal Size	Dimensions (mm)							Weight (kg)		
	DN	OD A	Thickness D	Raised Face Diam. G	Drilling			Bolt Size & Thread	SOW	Blind
					Bolt Circle Diam. K	Bolt Hole Diam H	Number of Bolts			
15	115	57	57	83	18	4	M16	0.8	1.0	
20	115	57	57	83	18	4	M16	0.9	1.0	
25	120	64	64	87	18	4	M16	1.1	1.2	
32	135	76	76	98	18	4	M16	1.5	1.8	
40	140	83	83	105	18	4	M16	1.7	2.0	
50	165	102	102	127	18	4	M16	2.6	3.1	
65	185	114	114	146	18	8	M16	3.1	3.8	
80	205	127	127	165	18	8	M16	4.3	5.4	
90	215	140	140	178	18	8	M16			
100	230	152	152	191	18	8	M16	5.8	7.9	
125	280	178	178	235	22	8	M20	9.9	12.6	
150	305	210	210	260	22	12	M20	10.8	15.4	
200	370	260	260	324	22	12	M20	18.3	28.2	
250	430	311	311	381	26	12	M24	22.1	38.0	
300	490	362	362	438	26	16	M24	31.0	58.0	
350	550	419	419	495	30	16	M27	47.7	85.0	
400	610	483	483	552	30	20	M27	62.0	118.0	
450	675	533	533	610	33	20	M30	105.0	196.0	
500	735	597	597	673	33	24	M30			
550	785	648	648	724	33	24	M30			
600	850	699	699	781	36	24	M33			

Stainless Steel Bar

Round, Flat, Angle and Sections



6 Stainless Steel Bar Round,
Flat, Angle, Sections & Wires



6

Improved Machinery Bar



Atlas Steels distributes “Improved Machinability” (IM) Stainless Steel Bar.

Improved machinability bar results from a controlled melting process, giving high chip-breaking properties and providing a self-lubricating quality through the processing of machining.

Range of IM Grades

- 303, 304/304L and 316/316L round bar, 3.18 to 101.6mm
- 316/316L round bar, 101.6 to 304.8mm
- 303 and 316/316L hex bar, 13.34 to 57.15mm
- 316L – hollow bar

The benefits

- Improved machinability
- Increased cutting speeds
- Lower unit cost of production
- Increased tool life
- Lower production power requirements
- Consistent machinability
- Improved product surface finish
- Chemical composition within ASTM standards
- Properties the same as commercial grades of stainless steel
 - corrosion resistance
 - mechanical properties
 - weldability
 - formability
- improved drilling and tapping characteristics

IM grades will reduce wear on tools and extend tool life

Highly abrasive inclusions which damage tools are excluded in the IM manufacturing steel melt process.

There is a decrease in flank wear and crater wear of carbide tooling which results in:

- less dismounting and reassembling of tools
- less adjustment time; and
- a noticeable improvement in the life of cutting tools

Atlas Steels distributes Ugima “Improved Machinability” grades but also other generic brands are available.

Stainless steel bar comprises numerous products referred to by the shape, the section dimension, grade, condition and surface finish.

Shapes and Section Measurement



Round bar: measured across the diameter



Square bar: measured across the flats (A/F or AF)



Hexagonal bar: measured across the flats (A/F or AF)



Flat bar: measured width x thickness



Equal angle: measured leg length x thickness



Channels: measured flange width x web width x thickness



Hollow Bar: measured outside diameter (OD) x inside diameter (ID).
Some manufacturers describe as OD x Wall Thickness.

Grade

303, 304/304L, 316/316L, 321, 253MA, 416, 431, 2205, 630

Condition

H&T: Hardened and tempered

ANN: Annealed

PH: Precipitation hardened

Surface Finish

CD: Cold drawn

CG: Centreless ground

P&T: Peeled and turned

P: Polished

HF: Hot finished

RT: Rough turned / peeled

BD: Bright drawn

CF: Cold finished

ST: Smooth turned

SRE: Slit rolled edge

HRAP: Hot rolled annealed and pickled

PR: Peeled and reeled

Cold Finished is a generic term to cover: CD, CG, Peeled, Turned, BD and ST.

Dimensional Tolerances for Bar

Form and condition: Stainless Steel Bars				
Round			Square	Hexagonal
Centreless ground	Bright/Cold drawn	Cold finished/smooth turned		
h8 or h9	h9	h10	h11	h11

Note: Round bar stocked in sizes above 101.6mm is usually in a Rough Turned (Peeled) condition with an all-plus diameter tolerance.

Nominal bar size (mm)	Tolerance Number								
	6*	7*	8	9	10	11	12	13	14*
Up to 3	0.006	0.010	0.014	0.025	0.040	0.060	0.10	0.14	0.25
over 3 to 6	0.008	0.012	0.018	0.030	0.048	0.075	0.12	0.18	0.30
over 6 to 10	0.009	0.015	0.022	0.036	0.058	0.090	0.15	0.22	0.36
over 10 to 18	0.011	0.018	0.027	0.043	0.070	0.110	0.18	0.27	0.43
over 18 to 30	0.013	0.021	0.033	0.052	0.084	0.130	0.21	0.33	0.52
over 30 to 50	0.016	0.025	0.039	0.062	0.100	0.160	0.25	0.39	0.62
over 50 to 80	0.019	0.030	0.046	0.074	0.120	0.1490	0.30	0.476	0.74
over 80 to 120	0.022	0.035	0.054	0.087	0.140	0.220	0.35	0.54	0.87
over 120 to 180	0.025	0.040	0.063	0.100	0.160	0.250	0.40	0.63	1.00
over 180 to 250	0.029	0.046	0.072	0.115	0.185	0.290	0.46	0.72	1.15
over 250 to 315	0.032	0.052	0.081	0.130	0.210	0.320	0.52	0.81	1.30
over 315 to 400	0.036	0.057	0.089	0.140	0.230	0.360	0.57	0.89	1.40
over 400 to 500	0.040	0.063	0.097	0.155	0.250	0.400	0.63	0.97	1.55

Notes

Units are millimetres

h = all minus, k = all plus

* This table shows h tolerances across all tolerance classes.

k tolerances are in accordance with this table for tolerance classes k8 to k13 only.

k tolerances are not standardized for k14 and above.

Examples

25.40mm diameter bright drawn bar to h9 tolerance = +nil, -0.052mm

90mm diameter peeled bar to k12 tolerance = +0.35, -nil

Common Stainless Steel Bar Specifications

ASTM A276M	Hot or cold finished bar except bars for reforging (see ASTM A314). Includes rounds, squares, hexagons, hot rolled or extruded shapes such as angles, flats, channels and commonly used grades of stainless steel, including 'improved machinability'. Free machining grades such as 303 and 416 are not included (see spec. A582/A582M).
ASTM A479M	This specification covers the same sections as ASTM A276M, for use in pressure vessel construction. Also referred to in ASME boiler and pressure vessel code.
ASTM A582M	Hot or cold finished free-machining stainless steel bar (except bars for forging), primarily grades 303 and 416. These high sulphur grades have excellent machinability but reduced corrosion resistance, formability and weldability.
ASTM A484M	General requirements for stainless steel wrought bars, shapes, forgings and billets, under each ASTM specification.

Stainless Steel Round Bar – ASTM A276M

Condition: 25.4mm and less generally drawn, above 25.4mm and less than 101.6mm is generally annealed, turned and polished. Sizes above 101.6mm are generally rough turned to an all-plus tolerance

Grades: 431 and 2205 are often stocked in a smooth turned or centreless ground finish.

Diameter		Weight (kg/m)	Diameter		Weight (kg/m)
mm	inches		mm	Inches	
3.00	0.118	0.06	31.75	1.250	6.22
3.18	0.125	0.06	34.92	1.375	7.53
3.97	0.156	0.10	35.00	1.378	7.56
4.00	0.157	0.10	36.00	1.417	8.00
4.76	0.187	0.14	38.10	1.500	8.96
4.90	0.193	0.15	40.00	1.575	9.88
5.00	0.197	0.15	41.27	1.625	10.51
6.00	0.236	0.22	44.45	1.750	12.20
6.35	0.250	0.25	50.00	1.969	15.43
7.94	0.313	0.39	50.80	2.000	15.93
8.00	0.315	0.39	53.97	2.125	17.98
9.00	0.354	0.50	57.15	2.250	20.16
9.52	0.375	0.56	60.00	2.362	22.22
10.00	0.394	0.62	63.50	2.500	24.89
11.11	0.437	0.76	69.85	2.750	30.12
12.00	0.472	0.89	76.20	3.000	35.84
12.70	0.500	1.01	82.55	3.250	42.07
14.00	0.551	1.21	88.90	3.500	48.79
14.28	0.562	1.26	95.25	3.750	56.00
15.87	0.625	1.55	100.00	3.937	61.73
16.00	0.630	1.58	101.60	4.000	63.72
17.46	0.687	1.88	114.30	4.500	80.65
18.00	0.709	2.00	127.00	5.000	99.56
19.05	0.750	2.24	140.00	5.512	120.99
20.00	0.787	2.47	152.40	6.000	143.37
22.00	0.866	2.99	165.00	6.496	168.06
22.23	0.875	3.05	177.80	7.000	195.15
24.00	0.945	3.56	203.20	8.000	254.89
25.00	0.984	3.86	205.00	8.071	259.42
25.40	1.000	3.98	228.60	9.000	322.59
28.58	1.125	5.04	254.00	10.000	398.26
30.00	1.181	5.56	304.80	12.000	573.80

Flat Bar – ASTM A276M

Finish: HRAP or SRE

Grades: 304, 316

Width (mm)	Thickness (mm)	Weight (kg/m)
12.00	3.00	0.29
	6.00	0.59
20.00	3.00	0.49
	5.00	0.82
	6.00	0.98
	10.00	1.63
25.00	3.00	0.61
	5.00	1.02
	6.00	1.23
	8.00	1.63
	10.00	2.04
	12.00	2.45
30.00	3.00	0.74
	5.00	1.23
	6.00	1.47
	8.00	1.96
	10.00	2.45
	12.00	2.94
40.00	3.00	0.98
	5.00	1.63
	6.00	1.96
	8.00	2.62
	10.00	3.27
	12.00	3.92
50.00	3.00	1.23
	5.00	2.04
	6.00	2.45
	8.00	3.27
	10.00	4.09
	12.00	4.91
	16.00	6.54
	20.00	8.18
	25.00	10.22

Width (mm)	Thickness (mm)	Weight (kg/m)
65.00	5.00	2.66
	6.00	3.19
	8.00	4.25
	10.00	5.31
75.00	12.00	6.38
	5.00	3.07
	6.00	3.68
	8.00	4.91
	10.00	6.13
	12.00	7.36
	16.00	9.81
	20.00	12.27
100.00	25.00	15.33
	6.00	4.91
	8.00	6.54
	10.00	8.18
	12.00	9.81
	16.00	13.08
	20.00	16.35
	25.00	20.44
150.00	6.00	7.36
	10.00	12.27
	12.00	14.72

HRAP – Hot rolled, annealed and pickled.**SRE** – Slit rolled edge.**Size Ranges:**

SRE – up to 5mm thick, all widths

SRE – 6mm thick up to and including 40mm width

HRAP – 6mm thick, 50mm and wider

HRAP – all thicknesses above 6mm

Lengths:

All SRE is 4mm long

All HRAP is 6mm long

Angle Bar – ASTM A276MCondition: HRAP
Grades 304, 316

Leg length		Thickness (mm)	Weight (kg/m)
mm	mm		
20.00	20.00	3.00	0.90
25.00	25.00	3.00	1.10
		5.00	1.80
		6.00	2.10
30.00	30.00	3.00	1.30
		4.00	1.80
		5.00	2.20
		6.00	2.05
40.00	40.00	3.00	1.80
		4.00	2.40
		5.00	2.90
		6.00	3.50
50.00	50.00	3.00	2.30
		4.00	3.00
		5.00	3.70
		6.00	4.40
		10.00	7.10
65.00	65.00	6.00	5.80
		10.00	9.40
75.00	75.00	6.00	6.80
		10.00	9.40
100.00	100.00	6.00	9.10
		10.00	14.90
		12.00	17.70

Hexagonal Bar – ASTM A276MCondition: cold drawn
Grades 303,316

'AF' across flats		Weight (kg/m)
mm	inches	
6.35	0.250	0.27
7.93	0.312	0.43
8.00	0.315	0.44
9.53	0.375	0.62
11.11	0.437	0.84
13.34	0.525	1.21
15.27	0.601	1.59
18.03	0.710	2.21
19.05	0.750	2.47
20.83	0.820	2.95
22.00	0.866	3.29
22.23	0.875	3.36
23.37	0.920	3.72
24.00	0.945	3.92
25.65	1.010	4.48
28.58	1.125	5.56
30.00	1.181	6.13
30.48	1.200	6.32
31.75	1.250	6.86
33.05	1.300	7.42
34.92	1.374	8.30
37.59	1.479	9.59
38.10	1.500	9.93
42.42	1.670	12.22
47.63	1.875	15.40
50.80	2.000	17.52
57.15	2.250	22.17
63.50	2.500	27.37

Square Bar – ASTM A276MCondition: cold drawn
Grades 304, 316

'AF' across flats		Weight (kg/m)
mm	inches	
6.00	0.240	0.28
6.35	0.250	0.32
8.00	0.310	0.50
9.52	0.370	0.71
10.00	0.930	0.78
12.00	0.470	1.13
12.70	0.500	1.26
14.00	0.550	1.54
15.88	0.630	1.98
16.00	0.630	2.01
19.05	0.750	2.84
20.00	0.790	3.14
25.00	0.980	4.90
25.40	1.000	5.06
31.75	1.250	7.90
32.00	1.260	8.03
38.10	1.500	11.38
40.00	1.570	12.54
50.80	2.000	20.23

Channels– ASTM A276MCondition: HRAP
Grades 304,316

Web (mm)	Flange (mm)	Thickness (mm)	Weight (kg/m)
50.0	25.0	3.0	2.2
80.0	40.0	5.0	6.0
100.0	50.0	4.0	6.2
100.0	50.0	5.0	7.6
100.0	50.0	6.0	9.0
150.0	75.0	6.0	13.8
250.0	100.0	9.0	27.5

Laser Fused Structural Sections

Specification: ASTM A1069M “Standard Specification for Laser-Fused Stainless Steel Bars, Plates and Shapes”

Laser Fused Structural Sections

Laser fused structural stainless steel sections are a new product range that has wide application in architecture, building and construction, machinery, food processing plants, automotive and shipbuilding, water and sewage treatment plants and petrochemical industries.

“**Low Impact**” Laser Fused sections are also produced with low heat input welding so that pre-polished special finish sections can be used for high-visibility prestige architectural applications.

Product Benefits

Laser fused sections are welded on automated lines ensuring sections with precise dimensions, minimal distortion, very small heat affected zone and fusion zone and all can be manufactured in small batch size.

Manufacturer

Montanstahl AG, located in Switzerland, are the world leader in production of standard and custom laser fused sections. The technology developed by Montanstahl utilises the advantages of laser welding to produce sections not feasible by other processes. Further details are given at <http://www.montanstahl.com/>

Grades

Common austenitic grades 304/304L, 316/316L are held in Atlas stock. Other grades available for non-stock products include 316Ti, duplex and super duplex stainless steels. A range of carbon steel grades is also available from the mill.

Laser Fused Shapes

Commonly available shapes

- Angles
- Channels
- Beams
- Tees

Specials available on request are limited only by the imagination! A vast range of shapes including box sections can be produced.

The size range possible includes thicknesses from 3mm to 50mm, heights or flange widths up to 2,000mm and lengths up to a maximum of 15m

Finishes

Standard finish is grit blasted mill finish. Other grit finishes and mirror polished are also available on request.

The Complete Stainless Steel Structural Package from Atlas Steels

The solution to all structural needs in stainless steel...

- Laser fused sections
- Hot rolled sections – angles, flats, channels
- Square & Rectangular Hollow sections
- Circular Hollow sections – welded or seamless pipe or tube
- Slotted Tube – single or double slot

A vast range of options including decorative finishes both standard and special.

For other products refer to the relevant section of this Atlas Product Reference Manual.

Bandsaw and hacksaw processing equipment



Within our Service Centres we operate automated bandsaw and hacksaw facilities offering a complete cutting service for your bar requirements. The local markets and regional centres are supported by the nearest capital city when required.

Maximum cutting diameter is 650mm.

For more details regarding our processing service please contact your nearest Service Centre.

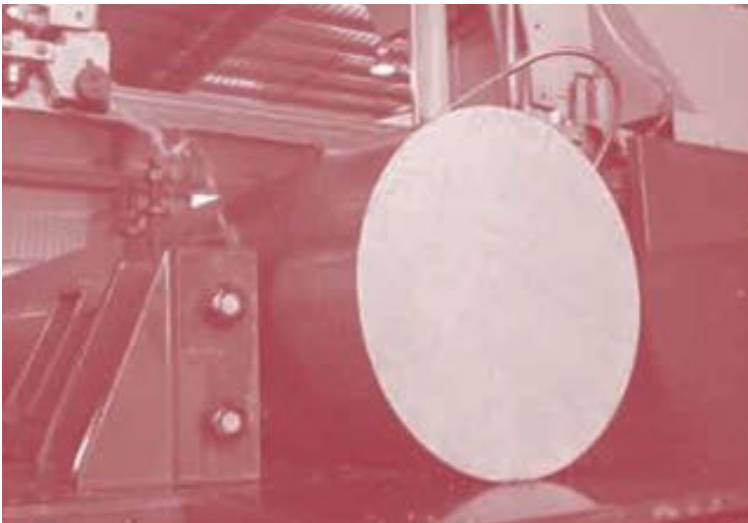

Aluminium Sheet, Coil, Plate, Treadplate & Extrusions



7 Aluminium Sheet, Coil, Plate, Treadplate & Extrusions



7

Aluminium



Advantages of using Aluminium

- Light weight – approximately $\frac{1}{3}$ the density of steel.
- Strength – some alloys can be substantially strengthened by work or by heat treatment.
- Workability – easy formability, machinability and readily welded.
- Corrosion resistance – varies depending on the alloy; the best resist marine exposure.
- Non-toxic – often used in contact with food.
- Non-magnetic and non-sparking.
- Electrical conductivity – very high; sometimes used for electrical conductors.
- Thermal conductivity – high.
- Reflectivity – bright finish options available.

Specifications

Flat rolled aluminium alloy products stocked by Atlas generally comply with ASTM B209M or ASTM B928M with dimensions in ANSI H35.2. There is very close agreement between these standards and Australian/New Zealand standard AS/NZS 1734 and again close agreement with European standard EN 573.

Aluminium Association publication “Aluminium standards and data” gives a very accessible summary of both specified data and useful information. Aluminium products are often cited as compliant with “AA specs” based on this.

Treadplate is specified in ASTM B632M but this does not cover the product well. Most mills produce to their own specifications and particularly to their own tread patterns. If tread pattern is important this should be discussed with Atlas staff prior to purchase.

Aluminium Alloy Compositions

Typical compositions of some common alloys. All values are percent.

Alloy	Al	Si	Cu	Mn	Mg	Cr	Others
1050	99.5 min						
1145	99.45 min						
1200	99.0 min						
2011	rem		5.5				Pb & Bi 0.4% each
2003	rem		0.12	1.2			
3004	rem			1.2	1.0		
3105	rem			0.6	0.50		
5005	rem				0.8		
5052	rem				2.5	0.25	
5083	rem			0.7	4.4	0.15	
5186	rem			0.4	4.3		
5251	rem			0.3	2.0		
5383	rem			0.8	4.6		
5454	rem			0.8	2.7	0.12	
6005	rem	0.8			0.5		
6060	rem	0.5			0.5		
6061	rem	0.6	0.28		1.0	0.20	
6063	rem	0.4			0.7		
6106	rem	0.4		0.1	0.6		
6262	rem	0.5	0.28		1.0	0.09	
6351	rem	1.0		0.6	0.6		

Only major alloying elements are listed.

Normal impurities are also present.

Refer to specifications for limits to both major elements and impurities

Alloy Characteristics and Forms

Alloy	Typical Application	Characteristics ¹				Commercial Form			
		Corrosion Resistace ⁴	Machin-ability	Welda-bility ³	Anodising ²	Plate	Sheet	Coil	Extrusions
1050	Chemical & process plant & equipment	A,A	D,C	A,A	B,B	✓	✓	✓	
1145 & 1200	Commercial pure aluminium. Used in cooking utensils and for deep frying.	A,A	D,C	A,A	B,B		✓	✓	
2011	Screw machine products not requiring decorative anodizing	D,D	A,A	D,D	D,D				✓
3003	Chemical equipment, sheet metal work, rigid foil containers & closures	A,A	D,C	A,A	B,B		✓	✓	
3004	Sheet metal work, car bodies, seam welding tubing, roofing sheet	A,A	D,C	A,A	B,B		✓	✓	
3105	Painted sheet products	A,A	D,C	A,A	B,B		✓	✓	
5005	Appliances & utensils, general sheet metal work & high-strength foil	A,A	D,C	A,A	B,B	✓	✓	✓	
5052 & 5251	Sheet metal work, appliances, marine applications	A,A	C,B	A,A	C,C	✓	✓	✓	
5083	High strength alloy used in transport, marine & structural applications	A,C	C,B	A,A	C,C	✓	✓		
5383	Specific to the marine industry with characteristics similar to 5083 with enhance weldability	A,C	C,B	A,A	C,C	✓	✓		
5454	Welded structures, pressure vessels for use at elevated temperatures, marine applications	A,A	C,B	A,A	C,C	✓	✓		
6005	Good strength for structural applications	A,A	B,C	A,A	B,B				✓
6061 & 6351	Structural applications where strength & corrosion resistance is needed. Used in transport applications.	B,B	B,C	A,A	B,B				✓
6063 & 6060	General purpose extrusion alloy for architectural applications where additional strength is required & for structural applications not involving welding	A,A	C,C	A,A	A,A				✓
6106	Medium strength alloy used for architectural applications where additional strength is required & for structural applications not involving welding.	A,A	C,C	A,A	A,A				✓
6262	Screw machining products suitable for decorative anodising	B,B	A,A	B,B	B,B				✓

¹ Relative ratings in decreasing order of merit = A B C D (where A = most applicable). Two ratings e.g. AC are for annealed and hardest tempers.

² Rating indicates suitability of alloy for decorative quality anodizing; all aluminium alloys can be anodized for increased corrosion and wear resistance. See separate note "Anodising Quality".

³ Weldability rating quoted is for arc welding. Some alloys have lesser weldability by gas processes.

⁴ General corrosion resistance rating. Resistance to stress corrosion cracking can be less.

Understanding an Alloy Code

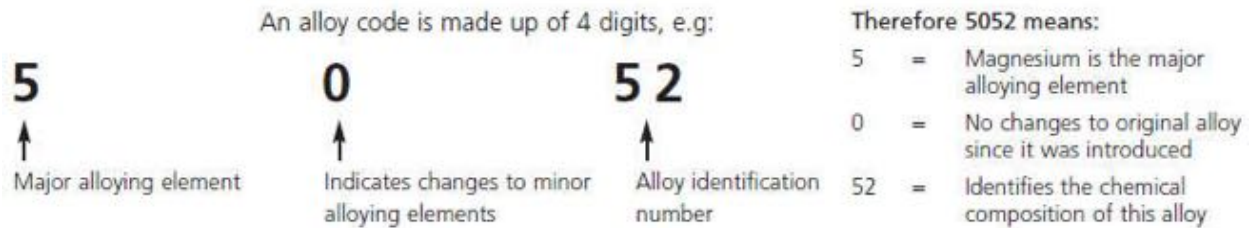

Alloy Systems

Alloy series	Major alloying element	Heat Treatable or Not
1??? =	Pure aluminium (99.0% min. and greatest)	Non-heat treatable
2??? =	Copper is major addition	Heat treatable
3??? =	Manganese is major addition	Non-heat treatable
4??? =	Silicon is major addition	Non-heat treatable
5??? =	Magnesium is major addition	Non-heat treatable
6??? =	Magnesium and Silicon are major additions	Heat treatable
7??? =	Zinc is major addition	Heat treatable
8??? =	Alloys not covered above	-

Non-heat treatable alloys can only be hardened by cold work. The degree of work hardening is designated by the Temper. Heat treatable alloys (the 2000, 6000 and 7000 series) are able to be solution treated and then age-hardened. These have "T" tempers.

"H" Temper designation systems	
Strain hardened alloys	
O	Soft (annealed)
H?2	¼ hard
H?4	½ hard
H?6	¾ hard
H?8	Hard

Where "?" can be:

1 = As rolled – - strain hardened only e.g. H12

2 = Strain hardened and then partially annealed (200°C – 260°C) e.g. H24

3 = Strain hardened and then stabilised (150°C) e.g. H36

Temper F – "as fabricated" temper with no special control over conditions and no mechanical property limits.

Three-Digit H Tempers

Plate Temper Codes

Code	Description
H111	Minor strain hardening so the product does not comply with annealed properties but also not enough hardening to comply with H11.
H112	Product strain hardened at elevated temperatures. Strength only slightly higher than annealed Temper O.
H116	5xxx series alloys for marine applications. Final operation is strain hardening. Strength equivalent to H32. Product is tested for intergranular and exfoliation corrosion resistance.
H321	5xxx series alloys for marine applications. Strain hardened and then thermally stabilised. Strength equivalent to H32. Product is tested for intergranular and exfoliation corrosion resistance.
H114	Treadplate in Alloys 3003 or 5052 rolled from Temper O.
H224	Treadplate in Alloys 3003 or 5052 rolled from Temper H21.

Note: Plate tempers generally restricted to ½ hard maximum owing to heavy gauge – cannot get sufficient cold work for higher tempers.

Plate and Sheet Standards

Standard	Description
ASTM B209	Product for a non-marine applications where additional corrosion testing is not required. This is typically applied to plate for the transport industry where surface finish and bright levels are critical. Material is ordered to a standard “H” temper e.g. H32. The material does not require identification line marking from the manufacturer.
ASTM B928	Typically a marine standard requiring additional testing for exfoliation and inter-granular corrosion resistance. Material for marine application is ordered as tempers H116 or H321 and possibly reference to an international recognised testing authority such as DNV. All material to this standard is line marked with manufacturing traceability.
DNV	Plate for marine applications can be supplied with testing certified by Det Norske Veritas (DNV).

Anodising Quality Aluminium Sheet

Atlas standard stock is not classified as “anodizing quality” and as such is not guaranteed to give acceptable anodizing appearance in any particular conditions. Much of this standard stock has been shown by considerable production experience to anodize well, particularly in smaller items and where exact colour consistency is not required. The acceptability of anodizing outcomes should be established by trial on a case by case basis with this product. Alloy 5005 is the usual choice for decorative anodized finishing. Other alloys can be anodized and this will improve corrosion resistance but the visual appearance may not be “decorative”. Trial anodising of any new alloy or source is always recommended.

Atlas can source “anodising quality” aluminium sheet, usually in grade 5005. Where exact colour matching is required across a batch or even between batches this should be discussed with Atlas sales staff.

Product Range

Aluminium Sheet

Note: Through external processing facilities all sheet product can be slit and cut to length for specific requirements. Linishing is also available.

Alloys	5005, 5052, 5251
Tempers	O, H32, H34, H38, H116, H321
Thickness range (mm)	0.15 to less than 6
Width range (mm)	900, 1200, 1500
Length range (mm)	1800, 2400, 3000, 3600

Other grades available on request.

Aluminium Coil/Strip

Note: Through external processing facilities, all coil product can be slit and cut to length for specific requirements. Linishing is also available.

Alloys	3003, 3004, 3105, 5005, 5052, 5251
Tempers	O, H32, H34, H38, H116, H321
Thickness range (mm)	0.15 to less than 6
Width range (mm)	25 to 1575

Aluminium Plate

Note: Through external processing facilities, all plate product can be slit and cut to length for specific requirements.

Alloys	5083, 5005, 5052, 5454, 5186
Tempers	H32, H34, H116, H321
Thickness range (mm)	6 to 25
Width range (mm)	1200 to 2500
Length range (mm)	2400 to 12000

Aluminium Treadplate

Note: Mill orders can be supplied to a customer's desired width and length.

Alloys (Commonly stocked)	5052, 3003
Tempers	O, H112, H114, H224
Finish	Standard 5 bar Mill Finish (Alloy 5052 Temper O, H114, H224)
	Propeller Pattern Bright (Alloy 3003 Temper H114, H224)
Thickness range (mm)	1.6 to 8
Width range (mm)	1200 to 1525
Length range (mm)	2400 to 6100

Aluminium Extrusions Product Range**Flat Bar**

Alloys	6060, 6063
Tempers	T5
Thickness	1.6mm to 10mm
Width	12mm to 100mm

Angle

Alloys	6060
Tempers	T5
Thickness	1.6mm to 3mm
Width	20 x 20mm to 50 x 50mm

Channel

Alloys	6060, 6063
Tempers	T5
Thickness	1.6mm to 3mm
Width	16 x 16mm to 50 x 25mm and 50 x 50mm

Square and Rectangular Hollow Sections

Alloys	6005, 6060, 6063
Tempers	T5
Thickness	1.6mm to 3mm
Width	20 x 20mm to 50 x 50mm, 25 x 40mm to 50 x 150mm

Non Standard Product Range

Aluminium product can be sourced outside the standard stock range nominated above. For such enquiries please contact the local Atlas sales office.

Finishes**Aluminium Plate**

- Elval Bright Transport Plate: this material is sourced from a select mill. Atlas market and stock this quality of plate in Alloy 5083, Temper H32.
- Mill Finish: this refers to plate supplied ex mill with a commercial finish. This material is typically used in the marine industry, general engineering and transport industry where bright plate is not critical.

Tread Plate

Pattern – 5 Bar
Available in Alloy 5052



Pattern – Propeller or 1 Bar
available in Alloy 3003



If tread pattern is critical this should be discussed with Atlas prior to purchase.

Mass per Square Metre (based on theoretical density of 2700kg/m³)

Thickness (mm)	Sheet/Plate	Thickness (mm)	Sheet/Plate	Treadplate	Thickness (mm)	Sheet/Plate	Treadplate
0.3	0.81		4.3			21.6	22.3
0.45	1.22	2	5.4		10	27.0	27.7
0.55	1.49	2.5	6.8	7.4	12	32.4	33.1
0.8	2.16	3	8.1		16	43.2	43.9
0.9	2.43	3.2	8.6	9.3	20	54.0	
1.0	2.70	4	10.8	11.5	25	67.5	
1.2	3.24	5	13.5	14.2	30	81.0	
1.5	4.05	6	16.2	16.9	40	108	
1.6		8					

Bending Radius Chart

Recommended minimum inside bending radii for 90 degree cold forming of sheet and plate ¹²³, bending transverse to rolling direction. Bending along the rolling direction may require a larger bend radius.

Radii for various thickness expressed in terms of thickness t									
Alloy	Temper	t=0.4mm	t=0.8mm	t=1.6mm	t=3.0mm	t=4.0mm	t=6.0mm	t=10.0mm	t=12.0mm
1050	O	0t	0t	0t	0t	0t	0.5t	0.5t	1t
1350	H12	0t	0t	0t	0t	0t	0.5t	1t	1.5t
1150	H14	0t	0t	0t	0.5t	0.5t	1t	1.5t	2t
	H16	0t	0t	0.5t	1t				
	H18	0.5t	1t	1.5t	2t				
1100 1200	O	0t	0t	0t	0t	0t	1t	1t	1.5t
	H12	0t	0t	0t	0.5t	1t	1t	1.5t	2t
	H14	0t	0t	0t	1t	1t	1.5t	2t	2.5t
	H16	0t	0.5t	1t	1.5t	1.5t	2.5t	3t	4t
	H18	1t	1.5t	2t	3t				
2024 ²	O	0t	1t	1t	1t	1t	1t	2.5t	4t
	T42	2.5t	3t	4t	5t	5t	6t	7t	8t
3033	O	0t	0t	0t	0t	0.5t	1t	1t	1.5t
3203	H12	0t	0t	0t	0.5t	1t	1t	1.5t	2t
3005	H14	0t	0t	0t	1t	1t	1.5t	2t	2.5t
5005	O	0	0	0	0	0.5t	1t	1t	1.5t
	H12	0	0	0	0.5t	1t	1t	1.5t	2t
	H14	0	0	0	1t	1.5t	1.5t	2t	2.5t
5005	H16	0.5t	1t	1t	1.5t				
	H18	1t	1.5t	2t	3t				
	H32	0t	0t	0t	0.5t	1t	1t	1.5t	2t
	H34	0t	0t	0t	1t	1.5t	1.5t	2t	2.5t
	H36	0.5t	1t	1t	1.5t	2.5t	3t	3.5t	4t
	H38	1t	1.5t	2t	2.5t	3.5t	4.5t	5.5t	6.5t
3004	O	0t	0t	0t	0.5t	1t	1t	1t	1.5t
	H32	0t	0t	0.5t	1t	1t	1.5t		
	H34	0t	1t	1t	1.5t	1.5t	2.5t		
	H36	1t	1t	1.5t	2.5t				
	H38	1t	1.5t	2.5t	3t				
5050	O	0t	0t	0t	0.5t	1t	1t	1t	1.5t
	H32	0t	0t	0t	1t	1t	1.5t		
	H34	0t	0t	1t	1.5t	1.5t	2t		
	H36	1t	1t	1.5t	2t				
	H38	1t	1.5t	2.5t	3t				
5052 5251	O	0t	0t	0t	0.5t	1t	1t	1.5t	1.5t
	H32	0t	0t	1t	1.5t	1.5t	1.5t	1.5t	2t
	H34	0t	1t	1.5t	2t	2t	2.5t	2.5t	3t
	H36	1t	1t	1.5t	2.5t	3t	3.5t	4t	4.5t
	H38	1t	1.5t	2.5t	3t	4t	5t	5.5t	6.5t
5154 5454	O	0t	0t	0.5t	1t	1t	1t	1.5t	1.5t
	H32	0t	0.5t	1t	1.5t	1.5t	2t	2.5t	3.5t
	H34	0.5t	1t	1.5t	2t	2.5t	3t	3.5t	4t
	H112						2t	2.5t	3t
5083	O			0.5t	1t	1t	1t	1.5t	1.5t
	H32			1t	1.5t	1.5t	1.5t	2t	2.5t
	H321			1t	1.5t	1.5t	1.5t	2t	2.5t
5086	O	0t	0t	1.5t	1t	1t	1t	1.5t	1.5t
	H32	0t	1.5t	1.5t	2t	2t	2t	2.5t	3t
	H34	0.5t	1t	1.5t	2t	2.5t	3t	3.5t	4t
	H36				3t	3.5t			
	H112 ³					1.5t	2t	2t	2.5t
6061 ²	O	0t	0t	0t	1t	1t	1t	1.5t	2t
	T4 & T42	0t	0.5t	1t	1.5t	2.5t	3t	3.5t	4t
	T6 & T62	1t	1t	1.5t	2.5t	3t	4t	4.5t	5t

Notes

¹ The radii listed are the minimum recommended for bending sheets and plates without fracturing in a standard press break with air bend dies. Other types of bending operations may require larger radii or permit smaller radii. The minimum permissible radii will also vary with the design and condition of tooling.

² Heat-treatable alloys can be formed over appreciably smaller radii immediately after solution heat treatment.

³ The H112 temper (applicable to non-heat treatable alloys) is supplied in the as-fabricated condition without special property control, but usually can be formed over radii applicable to the H14 (or H34) temper or smaller.



Atlas Steels Alfacade product specification

- Atlas Steels Alfacade is a 3mm or 4mm non-combustible pre-finished solid Aluminium panel tested to AS1530.1 and deemed non-combustible, the panels have also been tested and pass AS1530.3 requirements.
- Polyvinylidene flouride (PVDF) Coating system
- 20 years warranty, subject to standard terms and conditions.
- Atlas Steels Alfacade has been tested to AS 4284 and meets the weatherproofing requirements for FP1,4
- The Atlas Steels Alfacade is certified to ISO 9001:2015 & ISO 14001:2015 for designed, manufactured and coating system.

Material composition

Atlas Steels Alfacade is a 3.0mm + 4.0mm 3003 Series H22 100% solid aluminium panel, suitable for all Type A, B, & C class of construction.

- A. Protective film
- B. PVDF coating
- C. Pre-Treatment Layer
- D. 3mm or 4mm aluminium
- E. Protective wash coat to back of panel

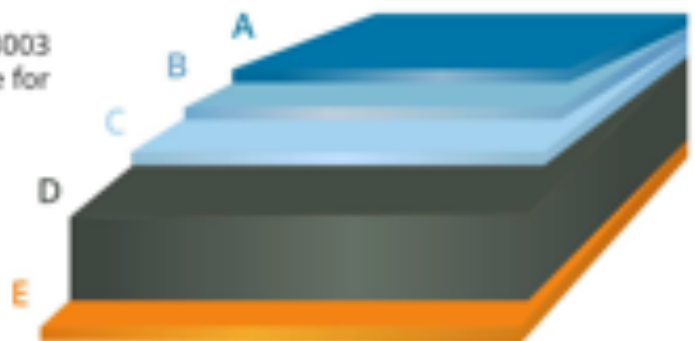

Standard panel dimensions

WIDTH	LENGTH	THICKNESS
1250 / 1575	2500 3200 4000	3mm / 4mm

**Note - Custom width & lengths are available with minimum MOQ per width and size.

Coating system

Atlas Steels Alfacade panels are coated with a Becker Group coating system, Beckers are a leading worldwide supplier of industrial coatings and the global market leader of coil coatings. Beckers are focused on developing sustainable coatings – their vision is to become the most sustainable industrial coatings company in the world. Beckers expertise is based on a long history dating back over 150 years, their history includes the manufacturing of high-performance coating solutions for a wide variety of applications, including an extensive range of colours

Atlas Steels Alfacade 2 or 3 coat polyvinylidene fluoride (PVDF) coating system is a pure thermoplastic fluoropolymer that is non-reactive & possesses multiple coating benefits .

PVDF coatings are especially resistant to solvents, acids & have a very low density compared to other fluoropolymers .

Atlas Steels Alfacade is able to be colour matched to any colour that the Architect, client, builder requires from any existing colour range (subject to minimum order quantities)



- Chemical resistance (ASTM D543): excellent
- Abrasion resistance (ASTM D4060): excellent
- PVDF coating thickness: 25 - 30 micron
- Gloss 20 – 80% matt/flat gloss
- Reverse = 7 micron grey wash coat

Beckers most UV-resistant topcoat system based on a blend of polyvinylidene fluoride and acrylic resins in 70/30. Available in mid to low gloss levels. Only the most durable pigments are used to achieve the Beckry®Fluor colour range.

Material Data

Test results

Test Standard	RESULT		
AS 1530.1	Non - Combustible		
AS 1530.3	PASS	Ignitability Index	0
	PASS	Heat Evolved	0
	PASS	Spread of Flame	0
	PASS	Smoke Developed	1

Thermal performance

Thermal resistance from -50°C To + 80°C

Test Standard	Thermal Resistance 1A M2 K/W	Thermal Resistance 1A M2 K/W

Material Data Sheet

Physical property	VALUE
Tensile strength – ultimate, Ft _u * (MPa)	179
Tensile strength – yield, Ft _y * (MPa)	158
Compressive strength, F _c (MPa)	131
Shear strength – ultimate, F _{su} (MPa)	83
Shear strength – yield, F _{su} (MPa)	69
Bearing strength – ultimate, F _{bu} (MPa)	276
Bearing strength – yield, F _{by} (MPa)	172
Compressive MOE, E (MPa)	70000
Thermal expansion coefficient	23
Fatigue strength (MPa)	60
Modulus of resilience (Kj/M ²)	130
Embodied carbon (kg-CO ₂ /kg)	8.1

Installation Details

The following list of installation considerations and details need to be taken into account prior to the start of panel installation:

- Atlas Steels Alfacade has a directional arrow on the protective film, ensure arrow direction is consistent with the installed cladding layout to prevent any variation in the finish due to light refraction/reflection.
- Different production lots may show as a minor colour variation a overall project order is recommended to ensure colour consistency across the project.
- When aluminium Z angles are installed onto galvanised top hats, an isolation tape/barrier should be used to separate dissimilar metals.
- Atlas Steels Alfacade is to be installed in a cassette fix method on Type A & B constructions, refer to the following installation drawing.
- Atlas Steels Alfacade panel is to be installed on a BCA compliant wall or wall system that meets the current NCC requirement, including variations of wall types for example, load bearing, non-load bearing, wall types that require a Fire Resistance Level (FRL)

Protective Film

- Ensure the protective film is completely removed from within express joints before they are caulked with silicon.
- To avoid glue residue on panel surface from exposure to weathering and UV light, the protective film will need to be removed from the panels within 45 days of installation. A clear protective film is also available (MOQ may apply) which needs to be removed within 25 days of installation.
- Under no circumstance should you apply PVC tapes, polyurethane or silicone sealant. These products can penetrate the film, or the panel surface, resulting in a change in the PVDF coating gloss level.
- Do not apply any spray paint or write with permanent marker on the protective film, as the colour may penetrate the film and affect the painted panel surface.
- After removal of the protective film ensure no scratches/damage will occur to the panel surface if still working within the area.

Installation Guidelines

General guideline, sequence of installation is as follows:

- Installation of an approved/compliant vapor permeable membrane as per manufacturers requirements.
- Installation of top hats vertically, ensuring they are levelled horizontally and vertically and fixed at appropriate centers to meet area / building wind loading requirements, with 10-12 gauge hex head class 3 screws.
- CNC fabricate and prepare Atlas Steels Alfacade for installation.
- Install Atlas Steels Alfacade panels to the top hats, then fix through the aluminium Z angles into top hats at the recommended centers for wind loading requirements.
- Caulking + backing rod applied to panel joints as per manufacturers recommendations, do not caulk panel joints if temperature is above 30°C.
- Remove all the protective film from Atlas Steels Alfacade within 45 days of installation.

Installation Drawings

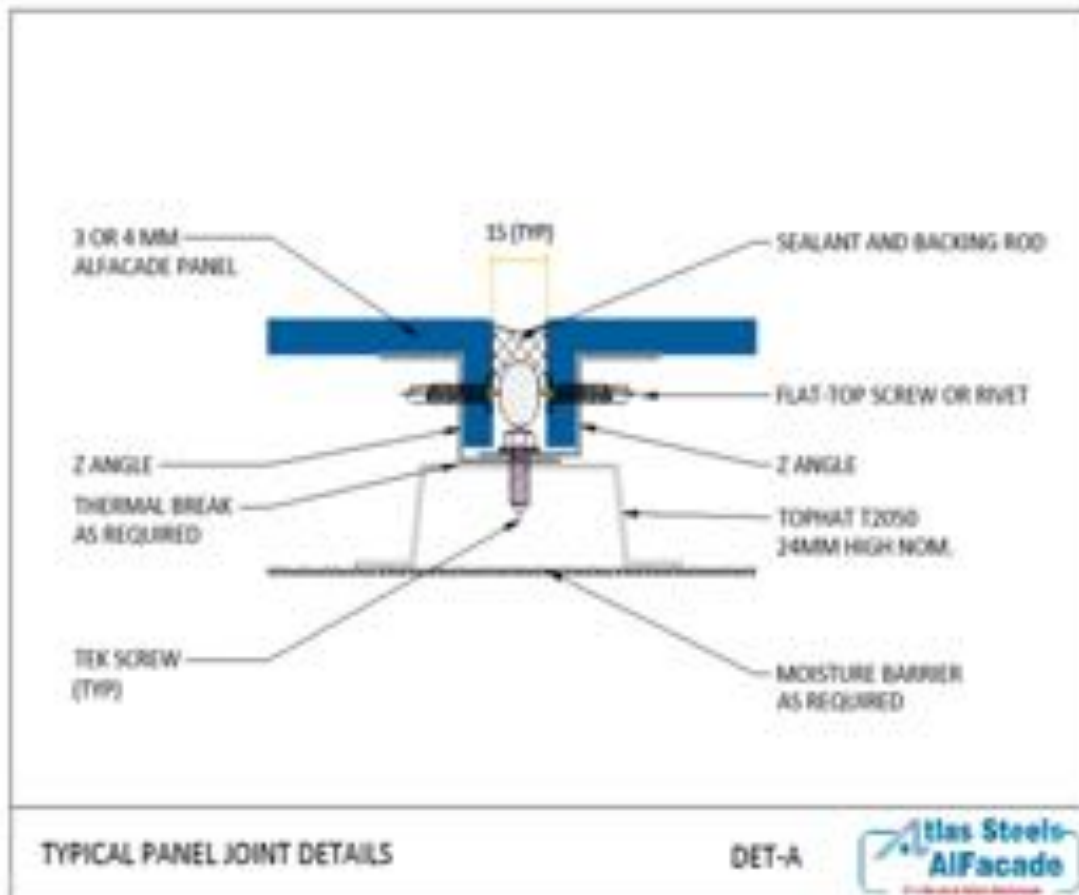

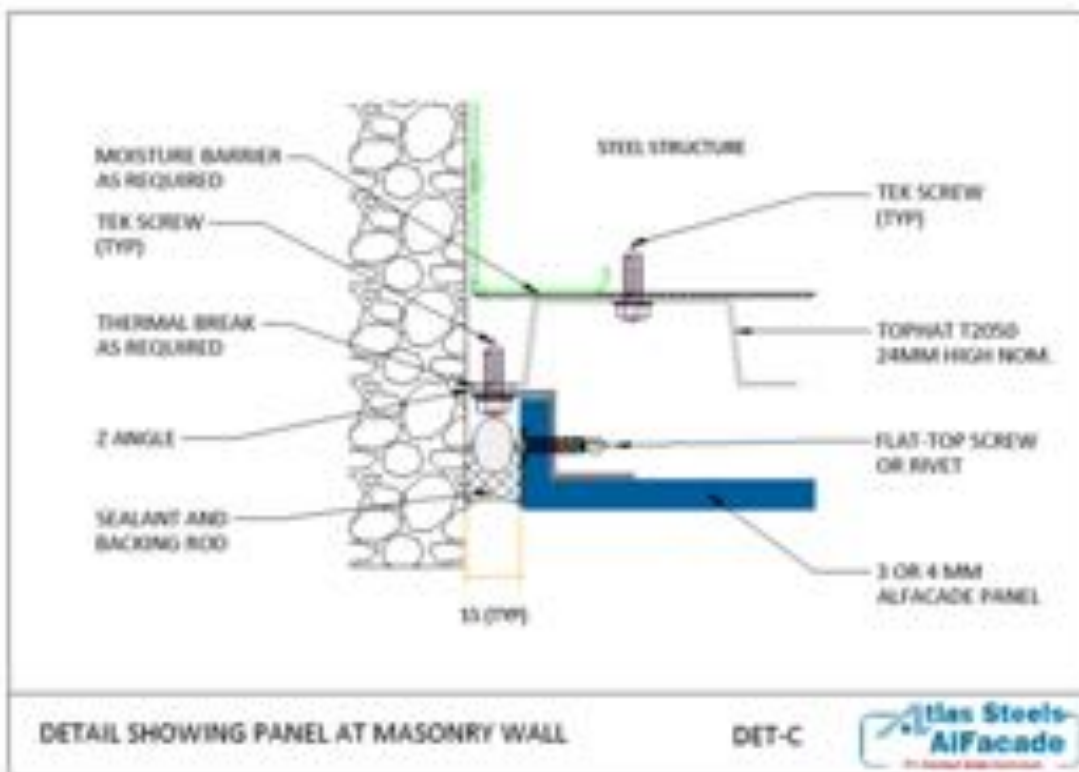
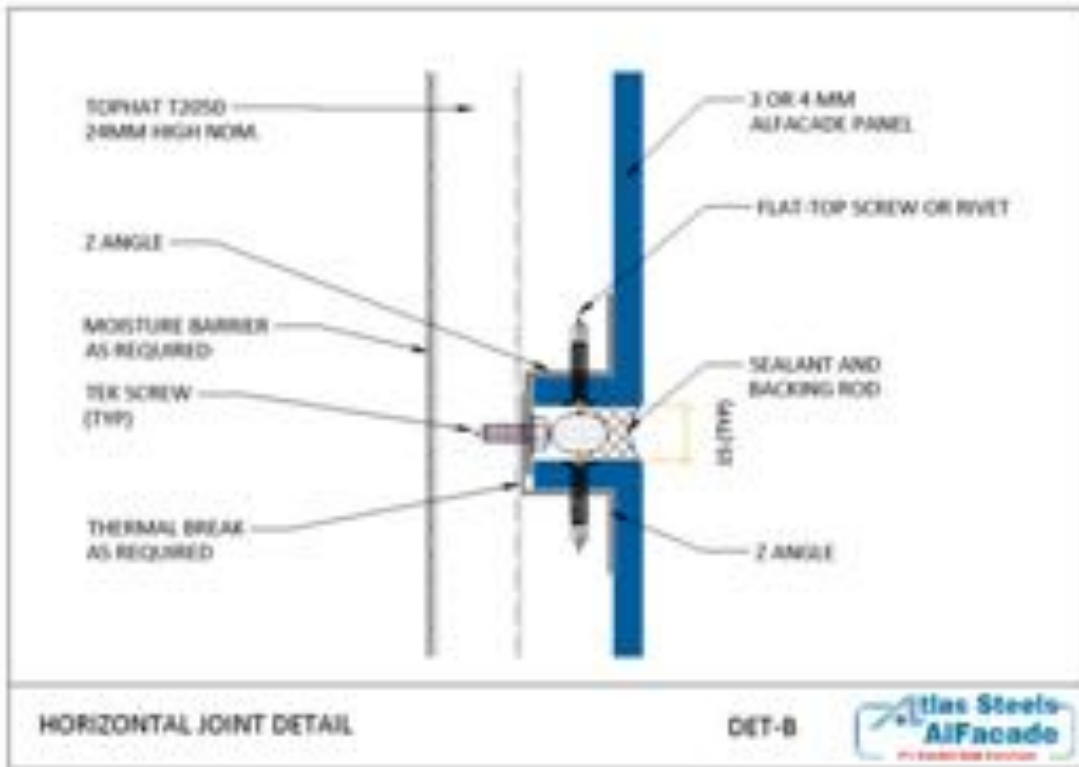

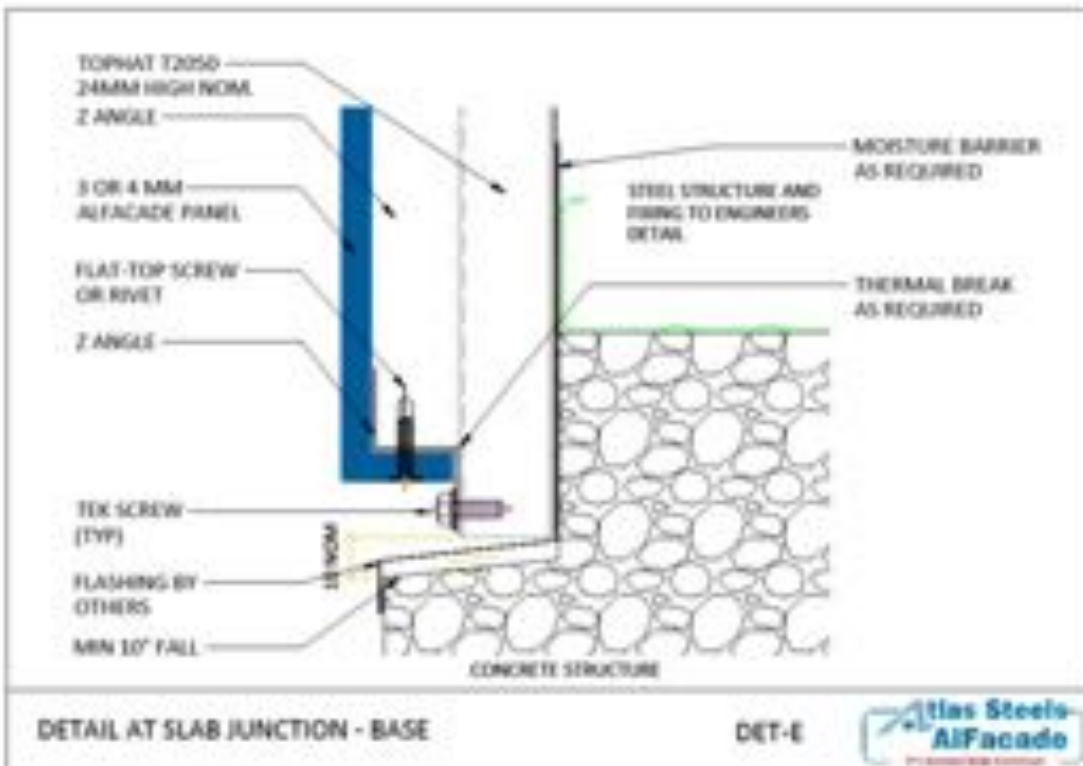
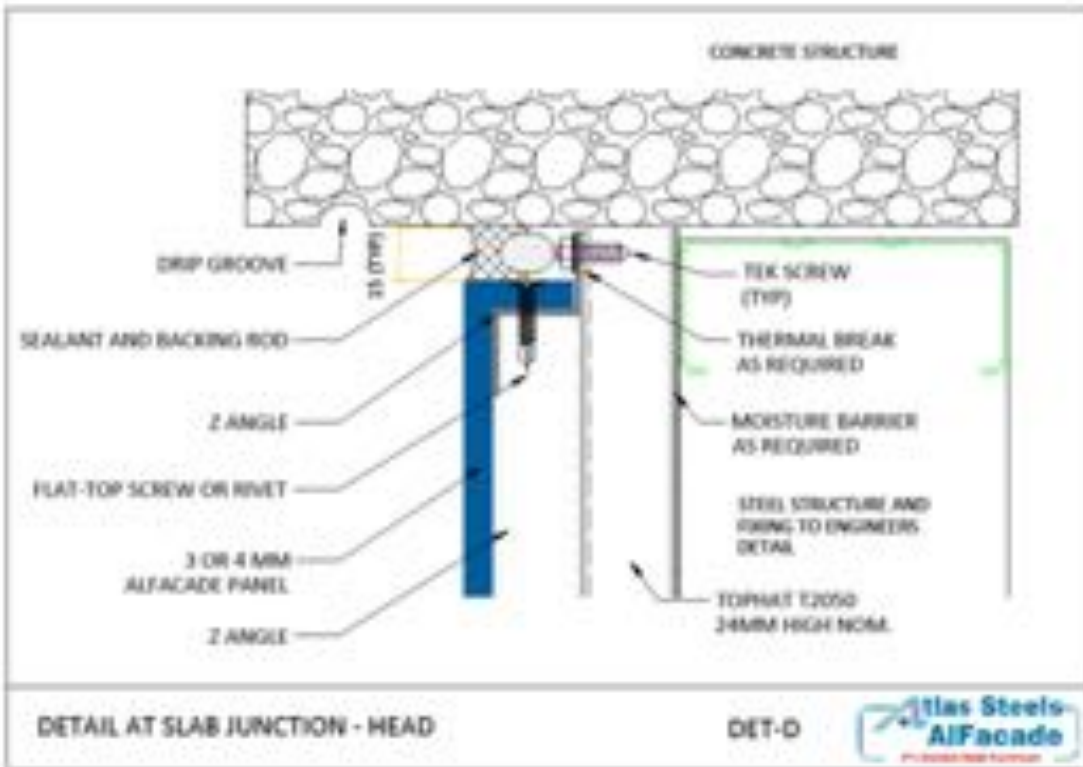

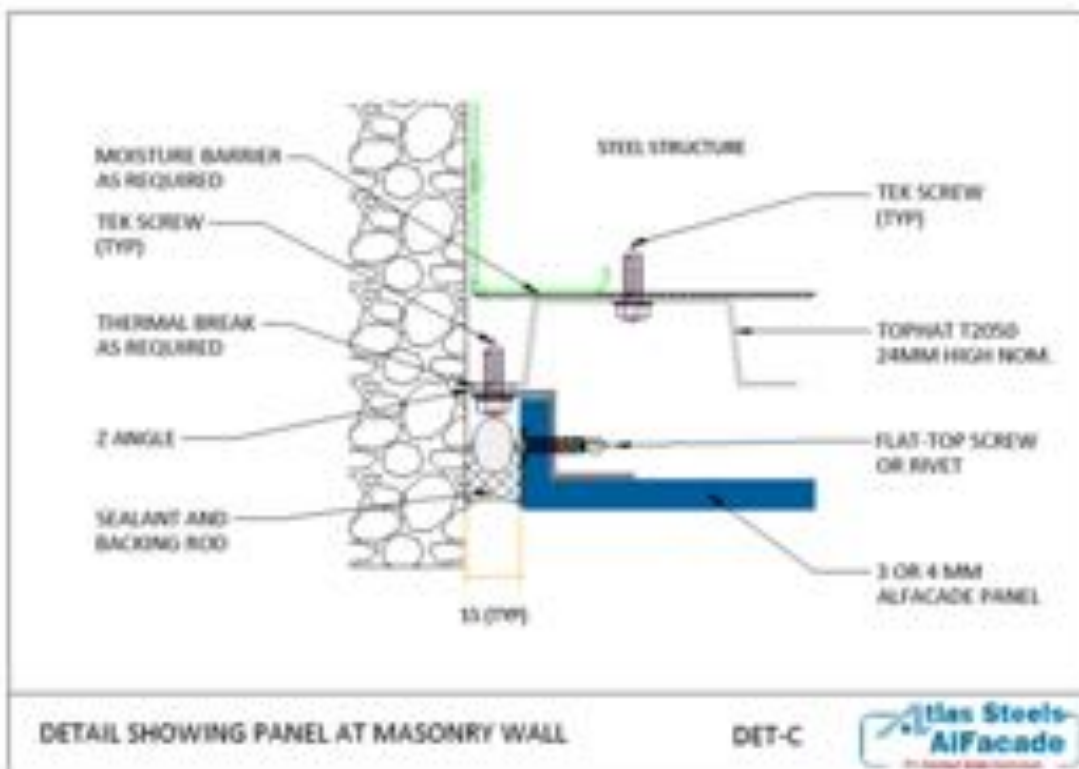
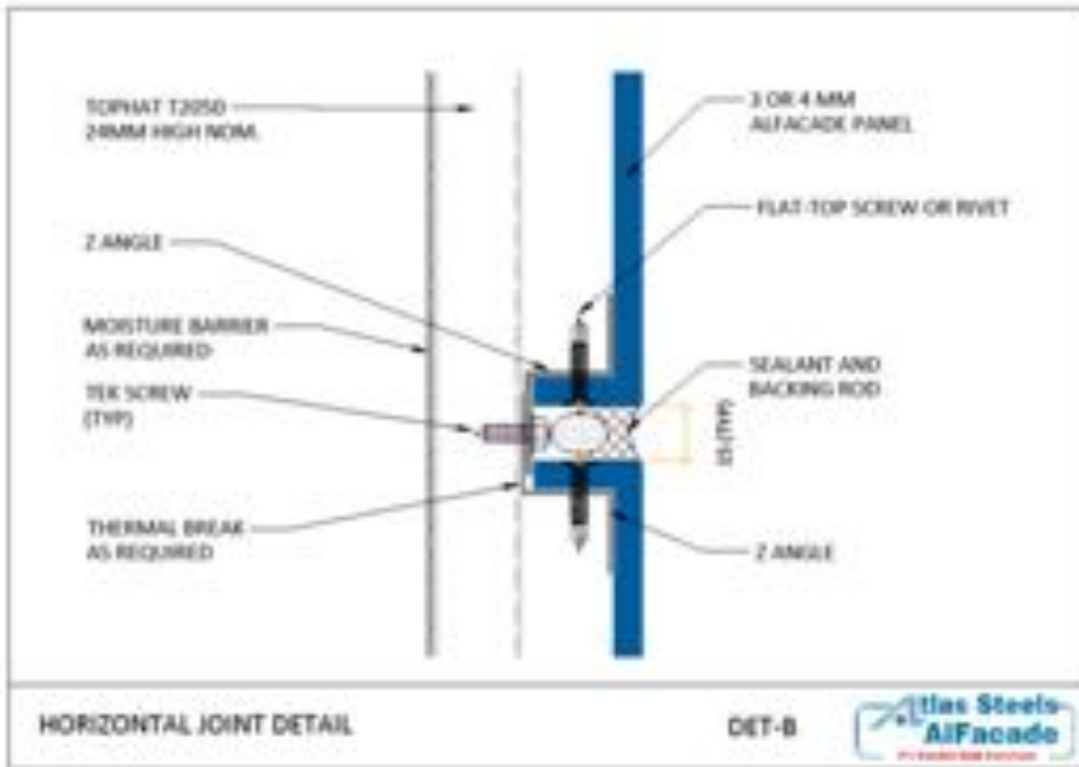

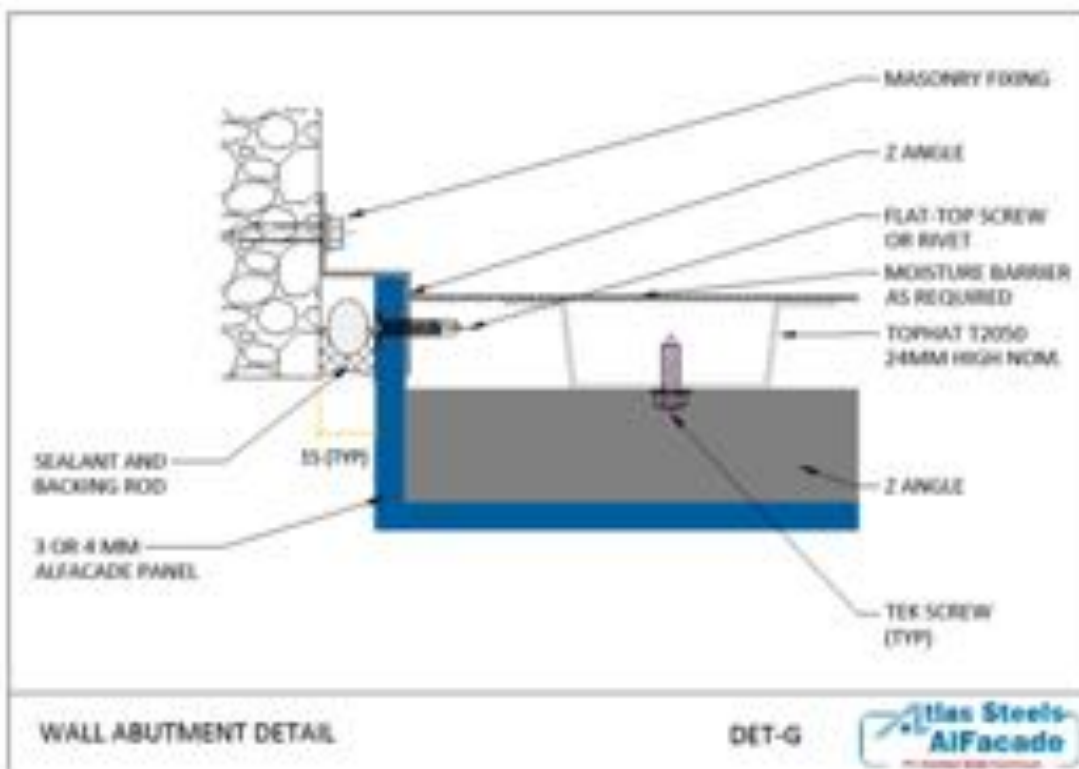
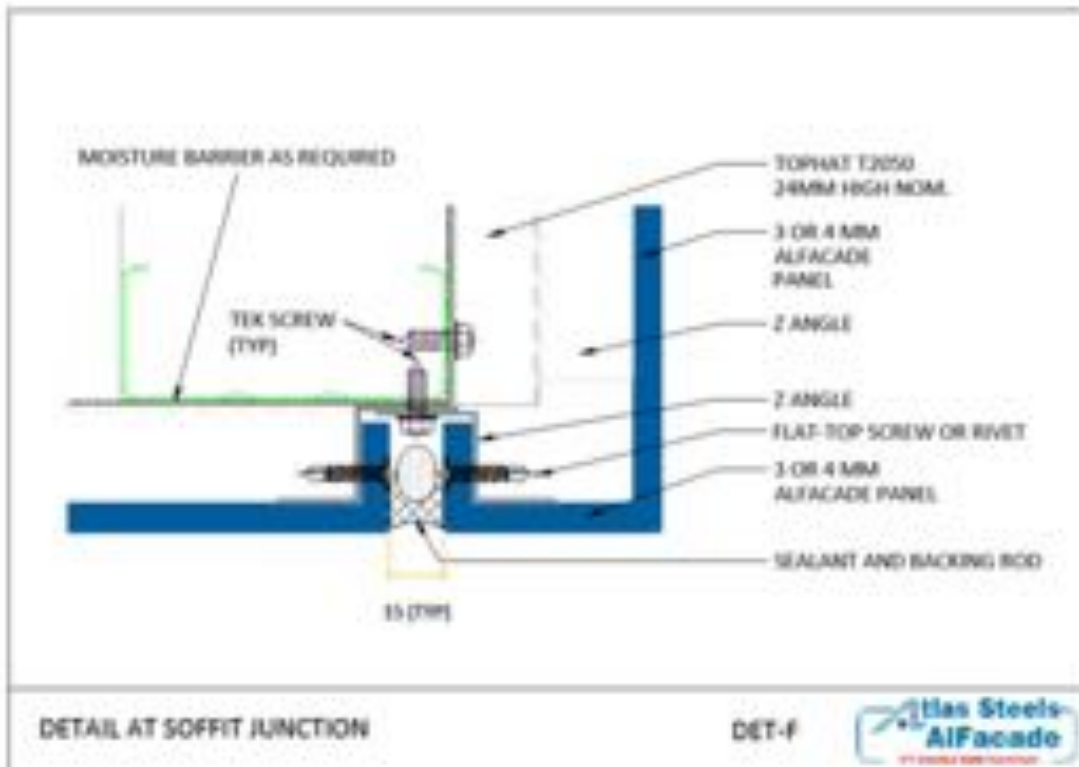

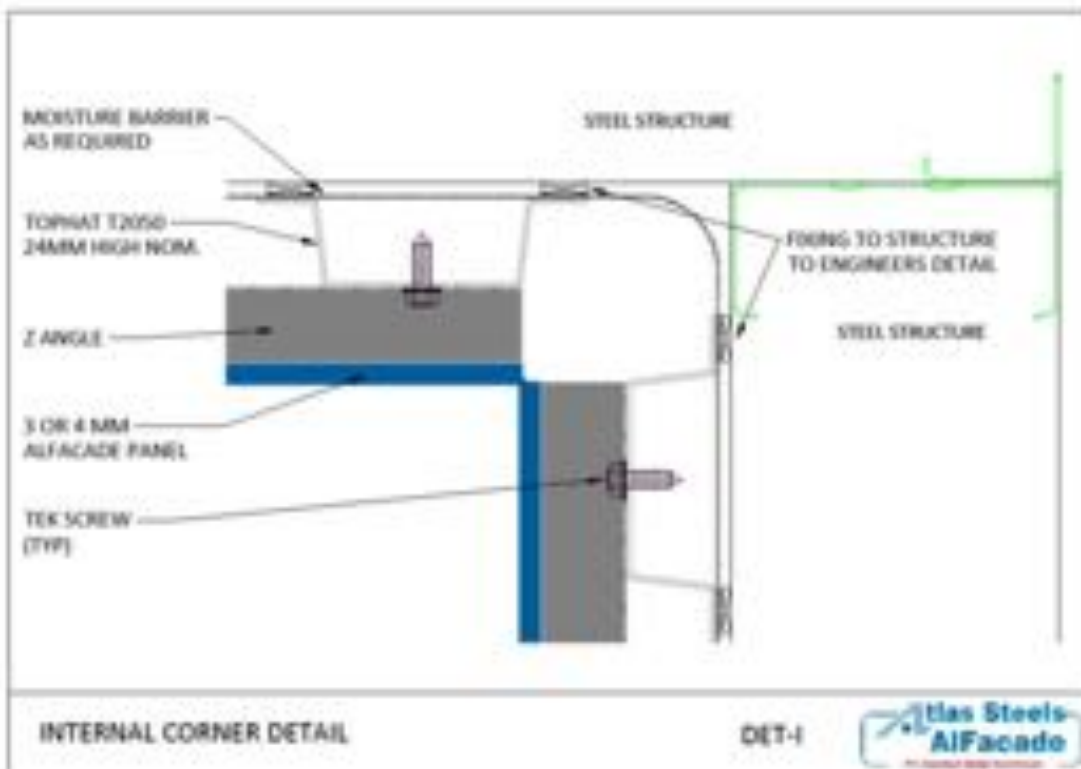
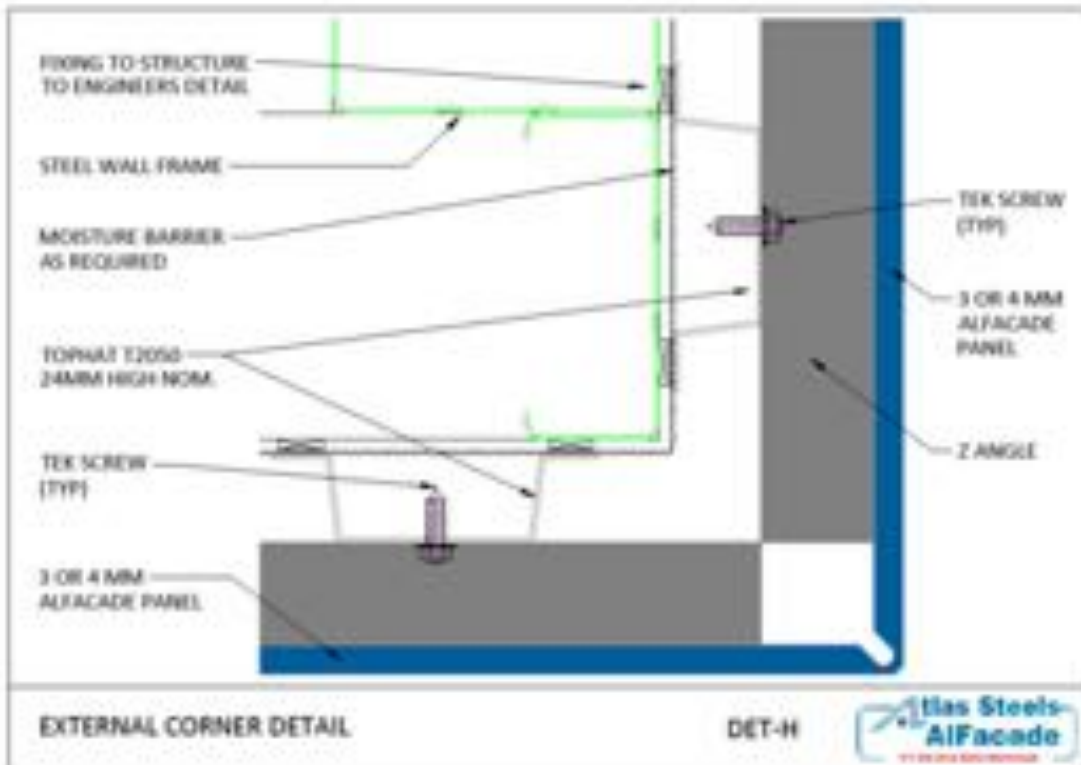

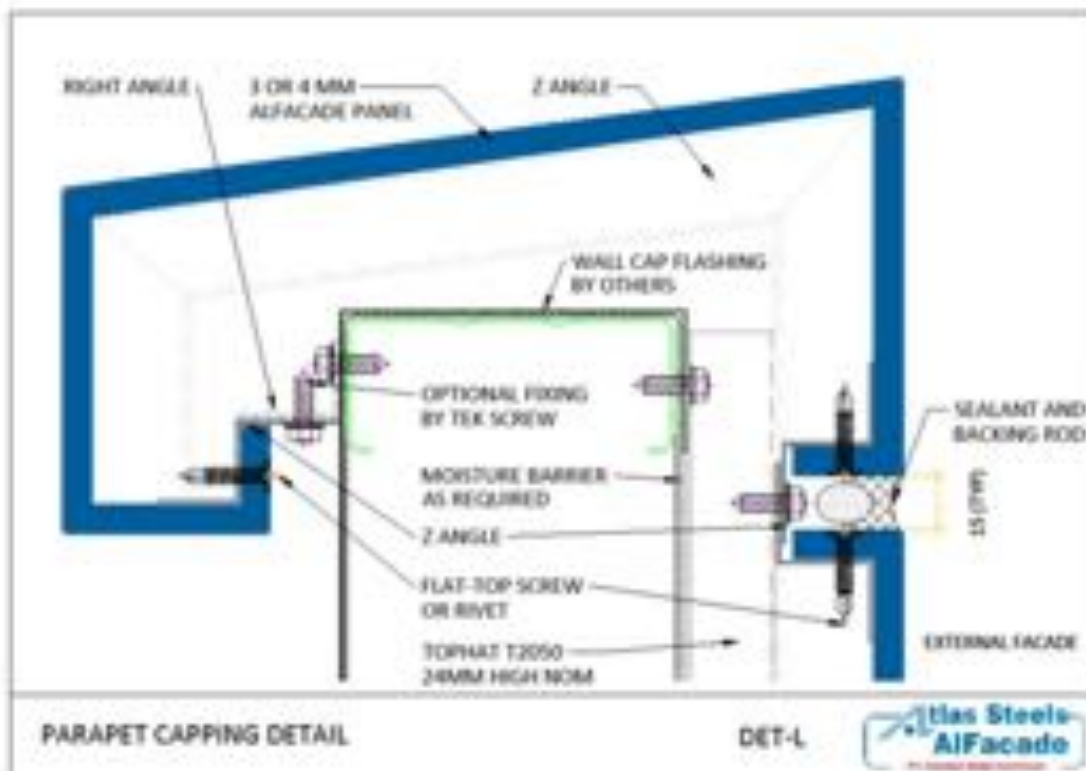
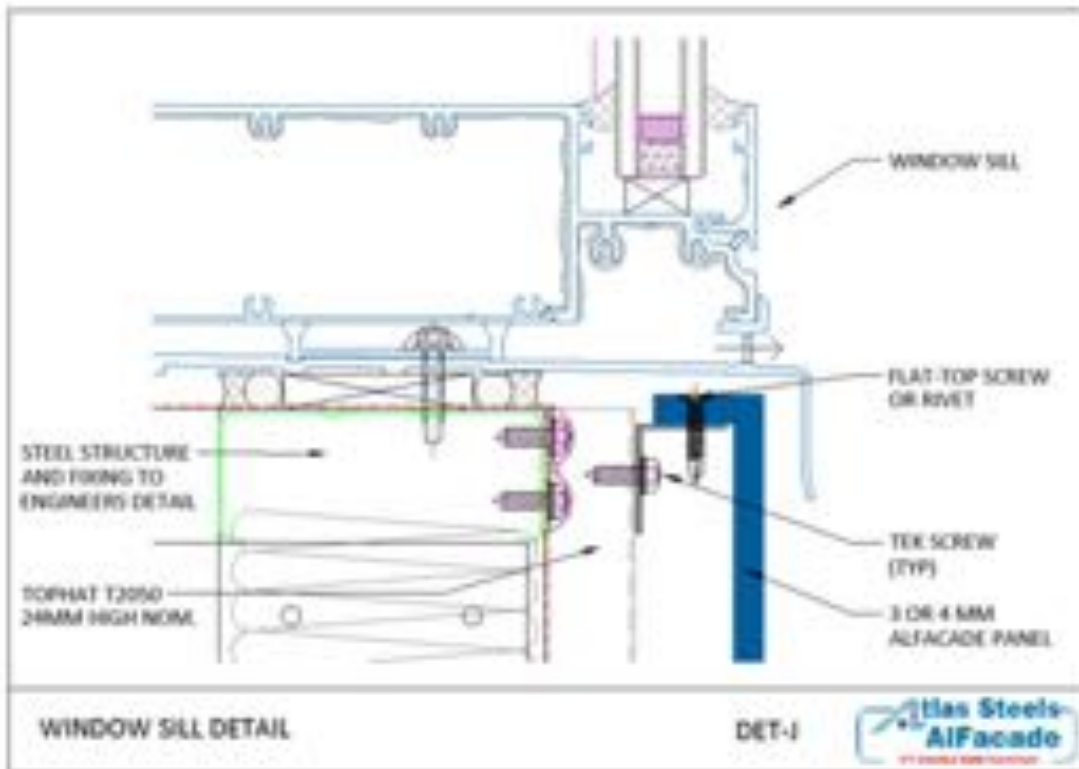

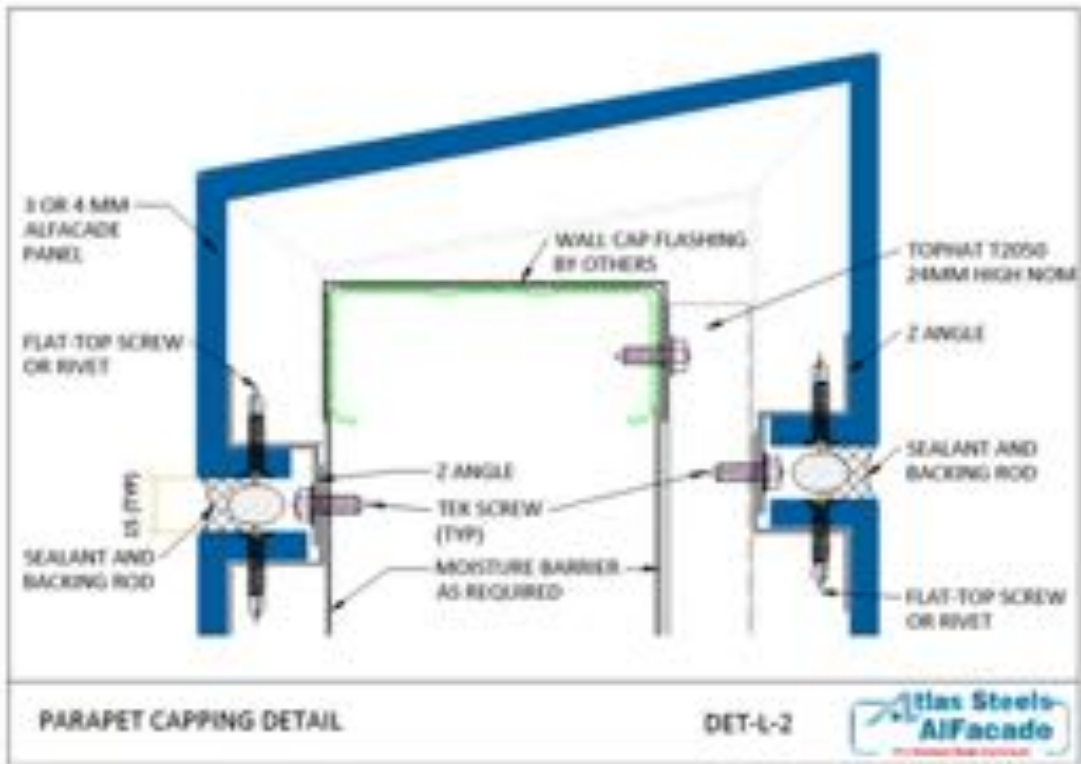

Atlas Steels Alfacade 3.0mm panel wind pressure table

Material AS/NZS
Properties 1664 3003
H22

E	70000 MPa	<- Compressive modulus of elasticity	<- AS/NZS 1664.1 Table 3.4 (A) for Alloy 3003 Group
G	26250 MPa	<- Shear modulus of elasticity	<- AS/NZS 1664.1 Clause 3.4.8.3
t	3.00 mm	<- Plate thickness	
F _{tu}	159 MPa	<- Tensile ultimate strength	<- Mill Certificate
F _{ty}	144 MPa	<- Tensile yield strength	<- Mill Certificate
F _{cy}	124 MPa	<- Compressive yield strength	<- Extrapolated from Table 3.3 (A) AS/NZS 1664.1 3003-H16
f _y	0.95	<- Yield capacity factor	<- AS/NZS 1664.1 Clause 3.4.2 & 3.4.3
f _u	0.85	<- Ultimate capacity factor	<- AS/NZS 1664.1 Clause 3.4.2 & 3.4.3
k _t	1.0	<- Coefficient for tension members	<- AS/NZS 1664.1 Table 3.4 (B)
f _{FL}	135 MPa	<- Limit state bending stress.	<- AS/NZS 1664.1 Clause 3.4.2 & 3.4.3

Flat plate, simply supported (4 sides) maximum principal stress at mid span due to wind pressure, W_{max}

$$W_{max} = \frac{p_w L^2}{24}$$

W _{max}	Panel width 'b'	Panel length 'L'							
		800.0 mm	1200.0 mm	1500.0 mm	1800.0 mm	2100.0 mm	2400.0 mm	2700.0 mm	3000.0 mm
1.0 kPa	600 mm	13.4 MPa	24.4 MPa	26.5 MPa	28.5 MPa	29.1 MPa	29.6 MPa	29.8 MPa	29.9 MPa
	900 mm	25.9 MPa	36.4 MPa	48.2 MPa	54.9 MPa	58.0 MPa	61.1 MPa	64.2 MPa	65.0 MPa
	1200 mm	68.2 MPa	46.0 MPa	61.3 MPa	71.6 MPa	88.9 MPa	97.6 MPa	101.8 MPa	105.9 MPa
	1500 mm	133.8 MPa	96.9 MPa	71.9 MPa	94.1 MPa	113.3 MPa	129.8 MPa	Stiffener R'd	Stiffener R'd
1.5 kPa	600 mm	29.1 MPa	34.6 MPa	39.7 MPa	42.8 MPa	43.6 MPa	44.5 MPa	44.7 MPa	44.9 MPa
	900 mm	38.8 MPa	57.5 MPa	72.3 MPa	82.4 MPa	87.0 MPa	91.7 MPa	96.3 MPa	97.5 MPa
	1200 mm	102.3 MPa	69.0 MPa	94.9 MPa	116.4 MPa	133.4 MPa	Stiffener R'd	Stiffener R'd	Stiffener R'd
	1500 mm	Stiffener R'd	Stiffener R'd	107.8 MPa	Stiffener R'd	Stiffener R'd	Stiffener R'd	Stiffener R'd	Stiffener R'd
2.0 kPa	600 mm	38.8 MPa	48.8 MPa	52.9 MPa	57.1 MPa	58.2 MPa	59.3 MPa	59.5 MPa	59.8 MPa
	900 mm	51.7 MPa	76.7 MPa	96.3 MPa	109.8 MPa	116.0 MPa	122.3 MPa	128.4 MPa	97.5 MPa
	1200 mm	Stiffener R'd	82.0 MPa	116.1 MPa	Stiffener R'd	Stiffener R'd	Stiffener R'd	Stiffener R'd	Stiffener R'd
	1500 mm	Stiffener R'd	Stiffener R'd	Stiffener R'd	Stiffener R'd	Stiffener R'd	Stiffener R'd	Stiffener R'd	Stiffener R'd
2.5 kPa	600 mm	48.5 MPa	61.0 MPa	66.2 MPa	71.3 MPa	72.7 MPa	74.1 MPa	74.4 MPa	74.8 MPa
	900 mm	64.7 MPa	95.9 MPa	120.4 MPa	Stiffener R'd	Stiffener R'd	Stiffener R'd	Stiffener R'd	Stiffener R'd
	1200 mm	Stiffener R'd	115.0 MPa	Stiffener R'd	Stiffener R'd	Stiffener R'd	Stiffener R'd	Stiffener R'd	Stiffener R'd
	1500 mm	Stiffener R'd	Stiffener R'd	Stiffener R'd	Stiffener R'd	Stiffener R'd	Stiffener R'd	Stiffener R'd	Stiffener R'd

- Notes:
- Roark's Formulae for Stress and Strain Table 11.4, Chapter 11, Page 500
 - Plate principal stress near fixings, equal spaced @ 200mm maximum centres, due to negative wind pressure can be calculated by multiplying Table Stress by 1.3. Stress at fixings shall be less than specified AS/NZS 1664.1 limit state bending stress, provided above. Where stress at fixings non-compliant, fixing spacing need to be reduced. In such case, consult manufacturer.

TABLE 11.4 Formulae for flat plates with straight boundaries and constant thickness

NOTE: This section is for flat plates with the following conditions: a) flat plates in plan, b) uniform, and other loads are orthogonal to stress. Due to the stress is direction parallel to the edges a and b respectively. c) a bending stress which is positive (due to the tension and compression in the top of the plate) is considered uniformly distributed. If a the maximum force per unit length applied to the other surface, compressive (or tensile) depends on the sign of the plate. d) the equivalent stress of tension or a flat member in a top-south end and a plate in a top-south end is $T = \frac{W_{max}}{24} = \frac{p_w L^2}{24} = \frac{p_w L^2}{24} = \frac{p_w L^2}{24} = \frac{p_w L^2}{24}$.

Case	Condition	Formulae and related specific values
1. Rectangular plate of simply supported	a) Uniformly loaded plate	$W_{max} = \frac{p_w L^2}{24}$ $W_{min} = \frac{p_w L^2}{24}$ $W_{max} = \frac{p_w L^2}{24}$
	b) Uniformly loaded plate	$W_{max} = \frac{p_w L^2}{24}$
	c) Uniformly loaded plate	$W_{max} = \frac{p_w L^2}{24}$

Atlas Steels Alfacade 4.0mm panel wind pressure table

Material AS/NZS
Properties 1664 3003
H22

E	70000 MPa	<- Compressive modulus of elasticity	<- AS/NZS 1664.1 Table 3.4 (A) for Alloy 3003 Group
G	26250 MPa	<- Shear modulus of elasticity	<- AS/NZS 1664.1 Clause 3.4.8.3
t	4.00 mm	<- Plate thickness	
F _{tu}	159 MPa	<- Tensile ultimate strength	<- Mill Certificate
F _{ty}	144 MPa	<- Tensile yield strength	<- Mill Certificate
F _{cy}	124 MPa	<- Compressive yield strength	<- Extrapolated from Table 3.3 (A) AS/NZS 1664.1 3003-H16
f _y	0.95	<- Yield capacity factor	<- AS/NZS 1664.1 Clause 3.4.2 & 3.4.3
f _u	0.85	<- Ultimate capacity factor	<- AS/NZS 1664.1 Clause 3.4.2 & 3.4.3
k _t	1.0	<- Coefficient for tension members	<- AS/NZS 1664.1 Table 3.4 (B)
f _{FL}	135 MPa	<- Limit state bending stress.	<- AS/NZS 1664.1 Clause 3.4.2 & 3.4.3

Flat plate, simply supported (4 sides) maximum principal stress at mid span due to wind pressure, W_{max}



$$W_{max} = \frac{p_{max} l^2}{24}$$

W_{max}	Panel width 'b'	Panel length 'l'							
		900.0 mm	1200.0 mm	1500.0 mm	1800.0 mm	2100.0 mm	2400.0 mm	2700.0 mm	3000.0 mm
1.0 kPa	600 mm	10.9 MPa	11.7 MPa	14.9 MPa	16.1 MPa	16.4 MPa	16.7 MPa	16.7 MPa	16.8 MPa
	900 mm	14.5 MPa	21.6 MPa	27.1 MPa	30.9 MPa	32.6 MPa	34.4 MPa	36.1 MPa	36.6 MPa
	1200 mm	28.4 MPa	25.9 MPa	35.6 MPa	43.7 MPa	50.0 MPa	54.9 MPa	57.2 MPa	59.6 MPa
	1500 mm	75.3 MPa	55.6 MPa	80.4 MPa	92.9 MPa	103.7 MPa	112.7 MPa	120.0 MPa	125.8 MPa
1.5 kPa	600 mm	16.4 MPa	20.6 MPa	21.3 MPa	24.1 MPa	24.5 MPa	25.0 MPa	25.1 MPa	25.2 MPa
	900 mm	21.8 MPa	32.4 MPa	40.6 MPa	46.3 MPa	48.9 MPa	51.6 MPa	54.2 MPa	54.9 MPa
	1200 mm	57.5 MPa	38.9 MPa	53.4 MPa	65.5 MPa	75.0 MPa	82.4 MPa	85.9 MPa	89.3 MPa
	1500 mm	112.9 MPa	83.4 MPa	110.6 MPa	134.4 MPa	155.6 MPa	169.1 MPa	180.0 MPa	188.7 MPa
2.0 kPa	600 mm	21.8 MPa	27.5 MPa	29.8 MPa	32.1 MPa	32.7 MPa	33.3 MPa	33.5 MPa	33.6 MPa
	900 mm	29.1 MPa	43.1 MPa	54.2 MPa	63.8 MPa	65.2 MPa	68.8 MPa	71.2 MPa	74.9 MPa
	1200 mm	76.7 MPa	51.7 MPa	71.2 MPa	87.3 MPa	100.1 MPa	109.8 MPa	114.5 MPa	119.1 MPa
	1500 mm	Stiffener R'd	111.2 MPa	140.8 MPa	175.8 MPa	205.8 MPa	227.4 MPa	Stiffener R'd	Stiffener R'd
2.5 kPa	600 mm	27.1 MPa	34.3 MPa	37.2 MPa	40.1 MPa	40.9 MPa	41.7 MPa	41.9 MPa	42.1 MPa
	900 mm	36.4 MPa	53.9 MPa	67.7 MPa	77.2 MPa	81.5 MPa	86.0 MPa	90.3 MPa	91.4 MPa
	1200 mm	95.9 MPa	64.7 MPa	89.0 MPa	109.1 MPa	125.1 MPa	Stiffener R'd	Stiffener R'd	Stiffener R'd
	1500 mm	Stiffener R'd	Stiffener R'd	161.0 MPa	193.3 MPa	Stiffener R'd	Stiffener R'd	Stiffener R'd	Stiffener R'd

- Notes:
- Roof's Formula for Stress and Strain Table (1.4, Chapter 11, Page 50)
 - Plate principal stress near fixings, equal spaced @ 300mm maximum centres, due to negative wind pressure can be calculated by multiplying Table Stress by 1.3. Stress at fixing shall be less than specified AS/NZS 1664.1 limit state bending stress, provided above. Where stress at fixings non compliant, fixing spacing need to be reduced. In such case, consult manufacturer.

TABLE 11.2 Formulae for flat plates with straight boundaries and constant thickness

NOTE: This section of Table 11.2 applies with the following restrictions: a flat plate in pure flexure, and other point-loads for stress, the ratio of the stress to distance parallel to the axis is not a constant. If a bending stress exists a constant value exists on the tension and compression at the top/bottom, an assumed constant thickness. If a constant force per unit length applied to the plate, uniformity of the boundary supports on the sides of the plate, or the equivalent ratio of constant force per unit length and end to give $\sigma_x = \frac{1}{2} \frac{W_{max}}{t^2} (1 - \frac{4x^2}{l^2})$, $\sigma_y = 0$ and $\tau_{xy} = 0$, if $\frac{b}{l} < 0.1$.

Form:	Form:	Form:																																																																																																																																				
Free and supports:	Free and supports:	Form:																																																																																																																																				
1. Rectangular plate, all edges simply supported	2. Uniformly loaded plate	3. Uniformly loaded plate, constant value of σ_x , σ_y , τ_{xy} distribution of τ_{xy}																																																																																																																																				
																																																																																																																																						
$\sigma_{max} = \frac{1}{2} \frac{W_{max}}{t^2} (1 + \frac{4x^2}{l^2})$ $\sigma_{min} = \frac{1}{2} \frac{W_{max}}{t^2} (1 - \frac{4x^2}{l^2})$ $\tau_{xy} = \frac{1}{2} \frac{W_{max}}{t^2} \frac{4x}{l^2}$	$\sigma_{max} = \frac{1}{2} \frac{W_{max}}{t^2} (1 + \frac{4x^2}{l^2})$ $\sigma_{min} = \frac{1}{2} \frac{W_{max}}{t^2} (1 - \frac{4x^2}{l^2})$ $\tau_{xy} = \frac{1}{2} \frac{W_{max}}{t^2} \frac{4x}{l^2}$	$\sigma_x = \frac{1}{2} \frac{W_{max}}{t^2} (1 + \frac{4x^2}{l^2})$ $\sigma_y = \frac{1}{2} \frac{W_{max}}{t^2} (1 - \frac{4x^2}{l^2})$ $\tau_{xy} = \frac{1}{2} \frac{W_{max}}{t^2} \frac{4x}{l^2}$																																																																																																																																				
<table border="1"> <thead> <tr> <th>$\frac{b}{l}$</th> <th>1.0</th> <th>1.2</th> <th>1.4</th> <th>1.6</th> <th>1.8</th> <th>2.0</th> <th>2.2</th> <th>2.4</th> <th>2.6</th> <th>2.8</th> </tr> </thead> <tbody> <tr> <td>1</td> <td>0.800</td> <td>0.780</td> <td>0.750</td> <td>0.710</td> <td>0.660</td> <td>0.600</td> <td>0.530</td> <td>0.460</td> <td>0.390</td> <td>0.320</td> </tr> <tr> <td>2</td> <td>0.800</td> <td>0.780</td> <td>0.750</td> <td>0.710</td> <td>0.660</td> <td>0.600</td> <td>0.530</td> <td>0.460</td> <td>0.390</td> <td>0.320</td> </tr> <tr> <td>3</td> <td>0.800</td> <td>0.780</td> <td>0.750</td> <td>0.710</td> <td>0.660</td> <td>0.600</td> <td>0.530</td> <td>0.460</td> <td>0.390</td> <td>0.320</td> </tr> </tbody> </table>	$\frac{b}{l}$	1.0	1.2	1.4	1.6	1.8	2.0	2.2	2.4	2.6	2.8	1	0.800	0.780	0.750	0.710	0.660	0.600	0.530	0.460	0.390	0.320	2	0.800	0.780	0.750	0.710	0.660	0.600	0.530	0.460	0.390	0.320	3	0.800	0.780	0.750	0.710	0.660	0.600	0.530	0.460	0.390	0.320	<table border="1"> <thead> <tr> <th>$\frac{b}{l}$</th> <th>1.0</th> <th>1.2</th> <th>1.4</th> <th>1.6</th> <th>1.8</th> <th>2.0</th> <th>2.2</th> <th>2.4</th> <th>2.6</th> <th>2.8</th> </tr> </thead> <tbody> <tr> <td>1</td> <td>0.800</td> <td>0.780</td> <td>0.750</td> <td>0.710</td> <td>0.660</td> <td>0.600</td> <td>0.530</td> <td>0.460</td> <td>0.390</td> <td>0.320</td> </tr> <tr> <td>2</td> <td>0.800</td> <td>0.780</td> <td>0.750</td> <td>0.710</td> <td>0.660</td> <td>0.600</td> <td>0.530</td> <td>0.460</td> <td>0.390</td> <td>0.320</td> </tr> <tr> <td>3</td> <td>0.800</td> <td>0.780</td> <td>0.750</td> <td>0.710</td> <td>0.660</td> <td>0.600</td> <td>0.530</td> <td>0.460</td> <td>0.390</td> <td>0.320</td> </tr> </tbody> </table>	$\frac{b}{l}$	1.0	1.2	1.4	1.6	1.8	2.0	2.2	2.4	2.6	2.8	1	0.800	0.780	0.750	0.710	0.660	0.600	0.530	0.460	0.390	0.320	2	0.800	0.780	0.750	0.710	0.660	0.600	0.530	0.460	0.390	0.320	3	0.800	0.780	0.750	0.710	0.660	0.600	0.530	0.460	0.390	0.320	<table border="1"> <thead> <tr> <th>$\frac{b}{l}$</th> <th>1.0</th> <th>1.2</th> <th>1.4</th> <th>1.6</th> <th>1.8</th> <th>2.0</th> <th>2.2</th> <th>2.4</th> <th>2.6</th> <th>2.8</th> </tr> </thead> <tbody> <tr> <td>1</td> <td>0.800</td> <td>0.780</td> <td>0.750</td> <td>0.710</td> <td>0.660</td> <td>0.600</td> <td>0.530</td> <td>0.460</td> <td>0.390</td> <td>0.320</td> </tr> <tr> <td>2</td> <td>0.800</td> <td>0.780</td> <td>0.750</td> <td>0.710</td> <td>0.660</td> <td>0.600</td> <td>0.530</td> <td>0.460</td> <td>0.390</td> <td>0.320</td> </tr> <tr> <td>3</td> <td>0.800</td> <td>0.780</td> <td>0.750</td> <td>0.710</td> <td>0.660</td> <td>0.600</td> <td>0.530</td> <td>0.460</td> <td>0.390</td> <td>0.320</td> </tr> </tbody> </table>	$\frac{b}{l}$	1.0	1.2	1.4	1.6	1.8	2.0	2.2	2.4	2.6	2.8	1	0.800	0.780	0.750	0.710	0.660	0.600	0.530	0.460	0.390	0.320	2	0.800	0.780	0.750	0.710	0.660	0.600	0.530	0.460	0.390	0.320	3	0.800	0.780	0.750	0.710	0.660	0.600	0.530	0.460	0.390	0.320
$\frac{b}{l}$	1.0	1.2	1.4	1.6	1.8	2.0	2.2	2.4	2.6	2.8																																																																																																																												
1	0.800	0.780	0.750	0.710	0.660	0.600	0.530	0.460	0.390	0.320																																																																																																																												
2	0.800	0.780	0.750	0.710	0.660	0.600	0.530	0.460	0.390	0.320																																																																																																																												
3	0.800	0.780	0.750	0.710	0.660	0.600	0.530	0.460	0.390	0.320																																																																																																																												
$\frac{b}{l}$	1.0	1.2	1.4	1.6	1.8	2.0	2.2	2.4	2.6	2.8																																																																																																																												
1	0.800	0.780	0.750	0.710	0.660	0.600	0.530	0.460	0.390	0.320																																																																																																																												
2	0.800	0.780	0.750	0.710	0.660	0.600	0.530	0.460	0.390	0.320																																																																																																																												
3	0.800	0.780	0.750	0.710	0.660	0.600	0.530	0.460	0.390	0.320																																																																																																																												
$\frac{b}{l}$	1.0	1.2	1.4	1.6	1.8	2.0	2.2	2.4	2.6	2.8																																																																																																																												
1	0.800	0.780	0.750	0.710	0.660	0.600	0.530	0.460	0.390	0.320																																																																																																																												
2	0.800	0.780	0.750	0.710	0.660	0.600	0.530	0.460	0.390	0.320																																																																																																																												
3	0.800	0.780	0.750	0.710	0.660	0.600	0.530	0.460	0.390	0.320																																																																																																																												

Atlas Steels Alfacade Fabrication details



Cutting

Atlas Steels Alfacade can be cut using various types of saw with an appropriate type aluminium blade used in your circular saw, wall saw or jigsaw, consult with your supplier for best suited option. A cutting coolant system is recommended when processing.

Tool

(CNC) 4.76mm single flute upsiral cutter

Feed

1,500mm/minute

Spindle

21,000mm/minute

angle entry when cutting panel is recommended. Cutting fluid required.



Grooving

The preferred V-Groove-routing method of Atlas Steels Alfacade is to be done via CNC machine to maintain consistency, of routed depth, by leaving 0.7-1.0mm of material at the base of the route. A cutter coolant system is recommended when processing.

Tool

(CNC) 4.76mm single flute upsiral cutter

Feed

1,500mm/minute

Spindle

21,000mm/minute

NOTE: angle entry when routing panel is recommended. Cutting fluid required.



Radius/Profile cutting

The use of CNC machine, jigsaws and waterjet cutters are recommended for any curved profile cutting. A cutter coolant system is recommended when processing.



Folding

To fold the Atlas Steels Alfacade once routed, the use of pan break or a break press machine is recommended, especially for large format panels.



Shearing

Atlas Steels Alfacade panels can be guillotined face up for quick size processing of panels. Ensure the panel is protected from any potential damage during this process.



Perforating

Atlas Steels Alfacade can be punched/perforated by turret punch machines, always punch the panels face up to the tooling, as a general rule 3.0mm minimum spacing between punched holes is required.



Roll Bending

Mandril roller systems can be used to produce curved/radius in Atlas Steels Alfacade panels. Ensure roller sets are cleaned thoroughly before processing so not to damage the painted surface.



Screwing

When screw fixing Atlas Steels Alfacade the use of stainless, class 3 or 4 SDS steel screws are recommended. A facade washer can also be implemented to protect painted surface, thermal expansion/contraction also needs to be allowed for.



Riveting

When rivet fixing Atlas Steels Aifacade the use of stainless, or aluminium blind or solid rivets can be used. Protect painted surface from any possible damage, thermal expansion/contraction also needs to be allowed for.



Drilling

The use of high-speed steel (HSS) drills are recommended for any drilling required on Atlas Steels Aifacade, always drill from the panel face so not to bur the painted surface.



Bending

Atlas Steels Aifacade 3.0mm and 4.0mm panels can be folded by break press machines without having to be V routed, minor fracturing of the paint may occur which is acceptable under the Atlas Steels Aifacade warranty.

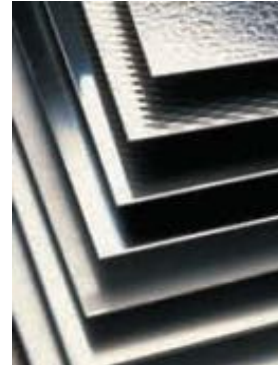
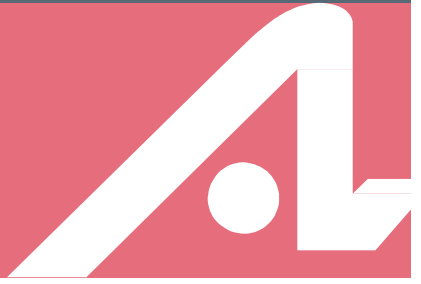

Stainless Steels – Properties & Equivalent Grades

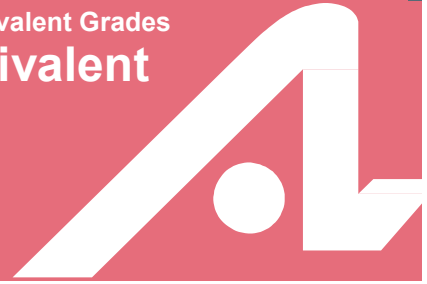

Type	Grade	UNS No	Old British		Euronorm		Swedish SS	Japanese JIS
			BS	En	No	Name		
Austenitic	201	S20100	-	-	1.4372	X12CrMnNiN17-7-5	-	SUS 201
	202	S20200	-	-	1.4373	X12CrMnNiN18-9-5	-	SUS 202
	301	S30100	301S21	-	1.4310	X10CrNi18-8	2331	SUS 301
	302HQ	S30430	394S17	-	1.4567	X3CrNiCu18-9-4	-	SUS XM7
	303	S30300	303S31	58M	1.4305	X8CrNiS18-9	2346	SUS 303
	304	S30400	304S31	58E	1.4301	X5CrNi18-10	2332	SUS 304
	304L	S30403	304S11	-	1.4307	X2CrNi18-9	2352	SUS 304L
	304H	S30409	-	-	1.4948	X6CrNi18-10	-	-
	304N	S30451	-	-	-	-	2371	SUS 304N1
	309S	S30908	309S24	-	1.4833	X12CrNi23-13	-	SUS 309S
	310H	S31009	310S24	-	-	-	-	SUH 310
	310S	S31008	310S16	-	1.4845	X8CrNi25-21	2361	SUS 310S
	316	S31600	316S31	58H,58J	1.4401	X5CrNiMo17-12-2	2347	SUS 316
	316L	S31603	316S11	-	1.4404	X2CrNiMo17-12-2	2348	SUS 316L
	316H	S31609	316S51	-	1.4919	-	-	-
	316N	S31651	-	-	1.4406	X2CrNiMoN17-11-2	2375	SUS 316N
	316Ti	S31635	320S31	-	1.4571	X10CrNiMoTi18-10	2350	SUS 316Ti
	317L	S31703	317S12	-	1.4438	X2CrNiMo18-16	2367	SUS 317L
	321	S32100	321S31	58B,58C	1.4541	X6CrNiTi18-10	2337	SUS 321
	347	S34700	347S31	58G	1.4550	X6CrNiNb18-10	2338	SUS 347
904L	N08904	904S13	-	1.4539	X1NiCrMoCuN25-20-5	2562	-	
253MA	S30815	-	-	1.4835	X9CrNiSiNCE21-11-2	2368	-	
4565S	S34565	-	-	1.4565	X2CrNiMnMoN24-17-6-4	-	-	
Ferritic	409	S40910	409S19	-	1.4512	X6CrTi12	-	SUH 409
	AtlasCr12	S41003	-	-	1.4003	X2CrNi12	-	-
	AtlasCR12Ti	-	-	-	-	-	-	-
	430	S43000	430S17	60	1.4016	X8Cr17	2320	SUS 430
	430F	S43020	-	-	1.4105	X6CrMoS17	2383	SUS 430F
	Atlas F20S	-	-	-	-	-	-	-
	444	S44400	-	-	1.4521	X1CrMoTi18-2	2326	SUS 444
446	S44600	-	-	1.4749	X18CrN28	2322	SUH 446	
Duplex	2101	S32101	-	-	1.4162	-	-	-
	2304	S32304	-	-	1.4362	X2CrNiN23-4	2327	-
	2205	S32250	318S13	-	1.4462	X2CrNiMoN22-5-3	2377	SUS 329J3L
	329	S32900	-	-	1.4460	X8CrNiMo27-5	2324	SUS 329J1
	2507	S32750	-	-	1.4410	X2CrNiMoN25-7-4	2328	-
	2507Cu	S32520	-	-	1.4507	X2CrNiMoCuN25-6-3	-	-
	Zeron100	S32760	-	-	1.4501	X2CrNiMoCuWN25-7-4	-	-
Martensitic	410	S41000	410S21	56A	1.4006	X12Cr13	2302	SUS 410
	416	S41600	416S21	56AM	1.4005	X12CrS13	2380	SUS 416
	420	S42000	420S37	56C	1.4021	X20Cr13	2303	SUS 420J1
	431	S43100	431S29	57	1.4057	X17CrNi16-2	2321	SUS 431
	440C	S44004	-	-	1.4125	X105CrMo17	-	SUS 440C
P.H	630	S17400	-	-	1.4542	X5CrNiCuNb16-4	-	SUS 630
	631	S17700	460S52	-	1.4568	X7CrNiAl17-7	2388	SUS 631

The above comparisons are approximate only - in some instances they are very close, in others much less so. The list is intended as a comparison of functionally similar materials not as a schedule of contractual equivalents. If exact equivalents are needed original specifications must be consulted.

Specified Compositions

Type	Grade	UNS	C	Mn	Si	P	S	Cr	Mo	Ni	N	Other
Austenitic	201	S20100	0.15	5.50-7.50	1.00	0.06	0.030	16.0-18.0		3.5-5.5		
	202	S20200	0.15	7.50-10.00	1.00	0.06	0.030	17.0-19.0		4.0-6.0		
	301	S30100	0.15	2.00	1.00	0.045	0.030	16.0-18.0		6.0-8.0	0.10	
	302HQ	S30430	0.030	2.00	1.00	0.045	0.030	17.0-19.0		8.0-10.0		3.0-4.0 Cu
	303	S30300	0.15	2.00	1.00	0.2	0.15min	17.0-19.0		8.0-10.0		
	304	S30400	0.07	2.00	0.75	0.045	0.030	17.5-19.5	-	8.0-10.5	0.10	
	304L	S30403	0.030	2.00	0.75	0.045	0.030	17.5-19.5	-	8.0-10.5	0.10	
	304H	S30409	0.04-0.10	2.00	0.75	0.045	0.030	18.0-20.0		8.0-10.5		
	304N	S30451	0.08	2.00	0.75	0.045	0.030	18.0-20.0		8.0-10.5	0.10-0.16	
	305	S30500	0.12	2.00	0.75	0.045	0.030	17.0-19.0		10.5-13.0		
	309S	S30908	0.08	2.00	0.75	0.045	0.030	22.0-24.0		12.0-15.0		
	310H	S31009	0.04-0.10	2.00	0.75	0.045	0.030	24.0-26.0		19.0-22.0		
	310S	S31008	0.08	2.00	1.50	0.045	0.030	24.0-26.0		19.0-22.0		
	316	S31600	0.08	2.00	0.75	0.045	0.030	16.0-18.0	2.00-3.00	10.0-14.0	0.10	
	316L	S31603	0.030	2.00	0.75	0.045	0.030	16.0-18.0	2.00-3.00	10.0-14.0	0.10	
	316H	S31609	0.04-0.10	2.00	0.75	0.045	0.030	16.0-18.0	2.00-3.00	10.0-14.0		
	316N	S31651	0.08	2.00	0.75	0.045	0.030	16.0-18.0	2.00-3.00	10.0-14.0	0.10-0.16	
	316Ti	S31635	0.08	2.00	0.75	0.045	0.030	16.0-18.0	2.00-3.00	10.0-14.0	0.10	5x(C+N)min, 0.70 max Ti
	317L	S31703	0.030	2.00	0.75	0.045	0.030	18.0-20.0	3.0-4.0	11.0-15.0	0.10	
	321	S32100	0.08	2.00	0.75	0.045	0.030	17.0-19.0		9.0-12.0	0.10	5x(C+N)min, 0.70 max Ti
347	S34700	0.08	2.00	0.75	0.045	0.030	17.0-19.0		9.0-13.0		10x(C+N)min, 1.0 max Nb	
904L	N08904	0.020	2.00	1.00	0.045	0.035	19.0-23.0	4.00-5.00	23.0-28.0	0.10	1.00-2.00 Cu	
253MA	S30815	0.05-0.10	0.8	1.40-2.00	0.040	0.030	20.0-22.0		10.0-12.0	0.14-0.20	0.03-0.08 Ce	

Single values are maxima.

Values listed are from ASTM A240M for flat rolled product, except for those grades only available in other products such as bar or wire, where limits in these ASTM specifications for these products are quoted.

Specified Compositions

Type	Grade	UNS	C	Mn	Si	P	S	Cr	Mo	Ni	N	Other
Ferritic	409*	S40910	0.030	1.00	1.00	0.040	0.020	10.5-11.7	-	0.50	0.03	6x(C+N)min, 0.50 max Ti
	AtlasCR12	S40977	0.030	1.50	1.00	0.040	0.015	10.50-12.50	-	0.30-1.00	0.03	
	AtlasCR12Ti	-	0.030	2.00	1.00	0.040	0.030	10.5-12.5	-	1.50	-	4x(C+N)min, 0.60 max Ti
	430	S43000	0.12	1.00	1.00	0.040	0.030	16.0-18.0	-	0.75	-	
	430F	S43020	0.12	1.25	1.00	0.060	0.15min	16.0-18.0	-	-	-	
	Atlas F20S	-	0.030	1.00	1.00	0.040	0.030	19.0-21.0	-	-	0.03	4x(C+N)min, 0.60 max Ti
	444	S44400	0.025	1.00	1.00	0.040	0.030	17.5-19.5	1.75-2.50	1.00	0.035	0.20+4x(C+N) Ti+Nb, 0.80max
446	S44600	0.20	1.50	1.00	0.040	0.030	23.0-27.0	-	0.75	0.25		
Duplex	2101	S32101	0.04	4.00-6.00	1.00	0.040	0.030	21.0-22.0	0.10-0.80	1.35-1.70	0.20-0.25	0.10-0.80 Cu
	2304	S32304	0.030	2.50	1.00	0.040	0.030	21.5-24.5	0.05-0.60	3.0-5.5	0.05-0.20	0.05-0.60 Cu
	2205	S32205	0.030	2.00	1.00	0.030	0.020	22.0-23.0	3.0-3.5	4.5-6.5	0.14-0.20	
	329	S32900	0.08	1.00	0.75	0.040	0.030	23.0-28.0	1.00-2.00	2.0-5.0	-	
	2507	S32750	0.030	1.20	0.80	0.035	0.020	24.0-26.0	3.0-5.0	6.0-8.0	0.24-0.32	0.50 Cu
	2507Cu	S32520	0.030	1.50	0.80	0.035	0.020	24.0-26.0	3.0-4.0	5.5-8.0	0.20-0.35	0.50-2.00 Cu
	Zeron100	S32760	0.030	1.00	1.00	0.030	0.010	24.0-26.0	3.0-4.0	6.0-8.0	0.20-0.30	0.50-1.00 Cu, 0.50-1.00 W
Martensitic	410	S41000	0.08-0.15	1.00	1.00	0.040	0.030	11.5-13.5	-	0.75	-	
	416	S41600	0.15	1.25	1.00	0.060	0.15 min	12.0-14.0	-	-	-	
	420	S42000	0.15 min	1.00	1.00	0.040	0.030	12.0-14.0	-	-	-	
	431	S43100	0.20	1.00	1.00	0.040	0.030	15.0-17.0	-	1.25-2.50	-	
	440C	S44004	0.95-1.20	1.00	1.00	0.040	0.030	16.0-18.0	0.75	-	-	
P.H	630	S17400	0.07	1.00	1.00	0.040	0.030	15.0-17.5	-	3.00-5.00	-	3.00-5.00 Cu, 0.15-0.45Nb+Ta
	631	S17700	0.09	1.00	1.00	0.040	0.030	16.00-18.00	-	6.50-7.75	-	0.75-1.50 Al

Single values are maxima.

Values listed are from ASTM A240M for flat rolled product, except for those grades only available in other products such as bar or wire, where limits in these ASTM specifications for these products are quoted.

* Grade 409 now largely replaced by S40910, S40920 and S40930 – refer to specifications for details.

Specified Mechanical Properties

Type	Grade	UNS No	Tensile Strength (MPa) min	Yield Strength (MPa) min	Elongation (% in 50mm) min	Hardness max	
						Rockwell (HR B)	Brinell (HB)
Austenitic	201	S20100	515	260	40	95	217
	202	S20200	620	260	40	-	241
	301	S30100	515	205	40	95	217
	302HQ	S30430	(450)	(205)	(70)	-	-
	303	S30300	-	-	-	-	262
	304	S30400	515	205	40	92	201
	304L	S30403	485	170	40	92	201
	304H	S30409	515	205	40	92	201
	304N	S30451	550	240	30	95	217
	309S	S30908	515	205	40	95	217
	310H	S31009	515	205	40	95	217
	310S	S31008	515	205	40	95	217
	316	S31600	515	205	40	95	217
	316L	S31603	485	170	40	95	217
	316H	S31609	515	205	40	95	217
	316N	S31651	550	240	35	95	217
	316Ti	S31635	515	205	40	95	217
	317L	S31703	515	205	40	95	217
	321	S32100	515	205	40	95	217
	347	S34700	515	205	40	92	201
904L	N08904	490	220	35	90	-	
253MA	S30815	600	310	40	95	217	
4565S	S34565	795	415	35	100	241	
Ferritic	409	S40900	380	207	20	95	207
	AtlasCR12	S41003	455	275	18	20HRC	223
	AtlasCR12Ti	-	460	300	18	-	220
	430	S43000	450	205	22	89	180
	430F	S43020	(552)	(380)	(25)	-	262
	Atlas F20S	-	(510)	(360)	(29)	(78)	-
	444	S44400	415	275	20	96	217
446	S44600	450	276	20	-	219	
Duplex	2101	S32101	680	480	30	-	290
	2304	S32304	600	400	25	32HRC	290
	2205	S32205	620	450	25	31HRC	293
	329	S32900	620	485	15	28HRC	269
	2507	S32750	795	550	15	32HRC	310
	2507Cu	S32520	770	550	25	-	310
	Zeron100	S32760	750	550	25	-	270
Martensitic	410	S41000	480	275	16	-	-
	416	S41600	(517)	(276)	(30)	-	262
	420	S42000	(655)	(345)	(25)	-	241
	431 (H&T)	S43100	850-1000	635	11	-	248-302
	440C	S44004	(758)	(448)	(14)	-	269
P.H	630 (H900)	S17400	1310	1170	10	40HRC min	388 min
	631 (CH900)	S17700	1585	-	-	-	-

The above properties are specified for each grade's most common product - generally plate or bar in the solution treated condition. Different limits apply to some other products.

Values in parentheses are typical; no values are specified. Original specifications must be consulted for definitive values.

Typical Physical Properties

Grade	UNS No.	Density kg/m ³	Elastic Modulus (a) GPa	Mean Coefficient of Thermal Expansion (b)			Thermal Conductivity		Specific Heat 0-100°C J/kg.K	Elect. Resis- tivity nΩ.m
				0-100°C µm/m/°C	0-315°C µm/m/°C	0-538°C µm/m/°C	at 100°C W/m.K	at 500°C W/m.K		
201	S20100	7800	197	15.7	17.5	18.4	16.2	21.5	500	690
202	S20200	7800	-	17.5	18.4	19.2	16.2	21.6	500	690
301	S30100	8000	193	17.0	17.2	18.2	16.2	21.5	500	720
302HQ	S30430	8000	193	17.2	17.8	18.8	16.3	21.5	500	720
303	S30300	8000	193	17.3	17.8	18.4	16.2	21.5	500	720
304	S30400	8000	193	17.2	17.8	18.4	16.2	21.5	500	720
304L	S30403	8000	193	17.2	17.8	18.4	16.2	21.5	500	720
304H	S30409	8000	193	17.2	17.8	18.4	16.2	21.5	500	720
304N	S30451	8000	196	17.2	17.8	18.4	16.3	21.5	500	720
309S	S30908	8000	200	15.0	16.6	17.2	15.6	18.7	500	780
310H	S31009	7750	200	15.9	16.2	17.0	14.2	18.7	500	720
310S	S31008	7750	200	15.9	16.2	17.0	14.2	18.7	500	720
316	S31600	8000	193	15.9	16.2	17.5	16.3	21.5	500	740
316L	S31603	8000	193	15.9	16.2	17.5	16.3	21.5	500	740
316H	S31609	8000	193	15.9	16.2	17.5	16.3	21.5	500	740
316N	S31651	8000	196	15.9	16.2	17.5	14.4	-	500	740
316Ti	S31635	8000	193	15.9	16.2	17.5	16.3	21.5	500	740
317L	S31703	8000	200	16.5	17.0	18.1	14.4	-	500	790
321	S32100	8000	193	16.6	17.2	18.6	16.1	22.2	500	720
347	S34700	8000	193	16.6	17.2	18.6	16.1	22.2	500	720
904L	N08904	8000	200	15.0	-	-	13.0	-	500	850
253MA	S30815	7800	200	17.0	17.2	18.0	14.0	18.0	500	850
4565S	S34565	8000	190	14.5	16.3	17.2	14.5	-	510	920
409	S40900	7600	208	11.0	11.7	12.4	25.8	27.5	460	600
AtlasCR12	S41003	7740	200	10.8	11.3	12.5	30.5	40.0	480	570
AtlasCr12Ti	-	7740	200	10.8	11.3	12.5	30.5	40.0	480	570
430	S43000	7750	200	10.4	11.0	11.4	23.9	26.0	460	600
430F	S43020	7750	200	10.4	11.0	11.4	26.1	26.3	460	600
Atlas F20S	-	7700	210	11.5	12.0	12.5	21.3	-	450	700
444	S44400	7800	200	10.0	10.6	11.4	26.8	-	420	620
446	S44600	7800	200	10.4	10.8	11.2	20.9	24.4	500	670
2101	S32101	7800	200	13.0	14.0	-	16.0	-	500	800
2304	S32304	7800	200	13.0	-	-	16.0	-	470	850
2205	S32205	7805	200	13.7	14.7	-	19.0	-	450	850
329	S32900	7800	186	10.1	11.5	-	-	-	460	750
2507	S32750	7800	200	13.0	14.0	-	17.0	-	470	-
2507Cu	S32520	7810	205	13.5	14.0	14.5	17.0	-	450	850
Zeron100	S32760	7840	190	12.6	13.9	-	14.4	-	480	850
410	S41000	7750	200	9.9	11.4	11.6	24.9	28.7	460	570
416	S41600	7750	200	9.9	11.0	11.6	24.9	28.7	460	570
420	S42000	7750	200	10.3	10.8	11.7	24.9	-	460	550
431	S43100	7750	200	10.2	12.1	-	20.2	-	460	720
440C	S44004	7650	200	10.1	10.3	11.7	24.2	-	460	600
630	S17400	7750	196	10.8	11.6	-	18.4	22.7	460	800
631	S17700	7800	204	11.0	11.6	-	16.4	21.8	460	830

Units – (a) 1 GPa = 1000 MPa (b) µm/m/°C = microns/metre/°C = x10⁻⁶/°C

Properties given are typical for the annealed condition.

Magnetic Permeability of all 300 series austenitic steels in the annealed condition is approximately 1.02.

Specifications & Grade Designations

Australian “common usage” grades are based upon the ASTM (American Society for Testing and Materials) designations; variations of this system have also been adopted in many other countries, including USA, Canada and Japan, and are well-recognised throughout the rest of the world. Certain grades of stainless steel have no equivalents in this system, particularly some European and newer grades. All metals in regular production have been allocated UNS (Unified Numbering System) designations by ASTM and SAE; these are often referred to in ASTM and other national specifications. “EuroNorms” are increasingly used across the European Union; the grades are usually functionally compatible with ASTM / UNS grades, but may vary in their details.

Note that “AISI” was the organisation that first codified the three digit designation system, and steels are still widely referred to as eg “AISI 304”, but AISI is not a standards-writing body – such designations are well recognised but should not be used as specifications for products. Product specifications (such as ASTM A240M for stainless steel flat rolled) do use the same grade designations but have clear requirements for composition limits, and also for mechanical properties, dimensions, testing procedures etc.

Product Specifications

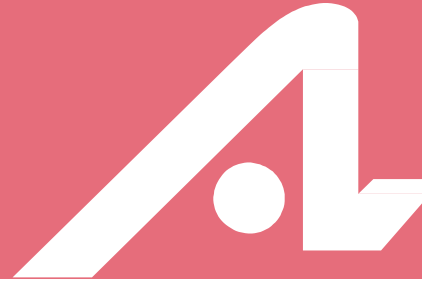

Stainless Steel Bar

Standard	Description
ASTM A276	Stainless and heat resisting steel bars and shapes.
ASTM A564/A564M	Hot rolled and cold finished age-hardening stainless and heat resisting steel bars and shapes.
ASTM A582	Free machining stainless and heat resisting steel bars and hot rolled or cold finished.
ASTM A193/A193M	Alloy steels and stainless steel bolting materials for high temperature service.
ASTM A194/A194M	Carbon and alloy steel nuts for bolts for high pressure and high temperature service.
ASTM A320/A320M	Alloy steel bolting materials for low temperature service.
ASTM A453/A453M	Bolting materials, high temperature 345 to 827MPa yield strength with expansion co-efficients comparable to austenitic steels.
ASTM A479/A479M	Stainless and heat resisting steel bars and shapes for use in boilers and other pressure vessels.
ASTM A484/A484M	General requirements for stainless and heat resisting steel bars, billets and forgings.
EN 10088-3	Stainless Steels – Part 3: Technical delivery conditions for semi-finished products, bars, rods and sections for general purposes.

Product Specifications

Stainless Steel Flat Product

Standard	Description
ASTM A167	Stainless and heat resisting chromium-nickel steel plate, sheet and strip.
ASTM A176	Stainless and heat resisting chromium steel plate, sheet and strip.
ASTM A240/A240M	Chromium and chromium-nickel stainless steel plate, sheet and strip for pressure vessels and general applications.
ASTM A263	Corrosion resisting chromium steel clad plate, sheet and strip.
ASTM A264	Stainless chromium-nickel steel clad plate, sheet and strip.
ASTM A265	Nickel and nickel base alloy clad steel plate.
ASTM A666	Austenitic stainless steel sheet, strip, plate and flat bar for structural applications.
ASTM A480/A480M	General requirements for flat rolled stainless and heat resisting steel plate, sheet and strip.
EN 10088-2	Stainless Steels – Part 2: Technical delivery conditions for sheet/plate and strip for general purposes.
Higher austenitic	
ASTM B625	UNS N08904 plate, sheet and strip

Stainless Steel Pipe

Standard	Description
ASTM A312/A312M	Seamless and welded austenitic stainless steel pipe.
ASTM A358/A358M	Electric-Fusion-Welded (EFW) austenitic chromium-nickel alloy steel pipe for high temperature service.
ASTM A409/A409M	Welded large diameter austenitic steel pipe for corrosive or high temperature service.
ASTM A731/A731M	Seamless and welded ferritic and martensitic stainless steel pipe.
ASTM A790/A790M	Seamless and welded ferritic/austenitic stainless steel pipe.
ASTM A450/A450M	General requirements for carbon, ferritic alloy and austenitic alloy steel tubes.
ASTM A530/A530M	General requirements for specialised carbon and alloy steel pipe.
ASTM A999/A999M	General requirements for alloy and stainless steel pipe.
JIS G3459	Stainless steel pipes.
ANSI/ASME B36.19M	Stainless steel pipe.
ASTM B673	UNS N08904 welded pipe.
ASTM B677	UNS N08904 seamless pipe and tube.

Product Specifications

Stainless Steel Pipe Fittings and Flanges

Standard	Description
ASTM A182/A182M	Forged or rolled alloy steel pipe flanges, forged fittings and valves and parts for high temperature service.
ASTM A403/A403M	Wrought austenitic stainless steel piping fittings.
ASTM A815/A815M	Wrought ferritic, ferritic/austenitic and martensitic stainless steel piping fittings.
AS 2129	Flanges for pipes, valves and fittings.
ASME B1.20.1	Pipe threads, general purpose (inch).
ANSI B16.5	Steel pipe flanges and flanged fittings.
ANSI B16.9	Factory-made wrought steel butt-welding fittings.
ANSI B16.11	Forged steel fittings socket-welding and threaded.
ANSI B16.25	Butt-welding ends.
MSS SP43	Wrought stainless steel butt-welding fittings.
BS21	BSP Threading – refer also AS ISO 7-1.
ISO 4144	Stainless steel fittings threaded to ISO 7-1.

Stainless Steel Tube and Fittings

Standard	Description
ASTM A213/A213M	Seamless ferritic and austenitic alloy steel boiler, superheater and heat exchanger tubes.
ASTM A249/A249M	Welded austenitic steel boiler, superheater, heat exchange and condenser tubes.
ASTM A269	Seamless and welded austenitic stainless steel tubing for general purposes.
ASTM A270	Seamless and welded austenitic stainless steel sanitary tubing.
ASTM A450/A450M	General requirements for carbon, ferritic alloy and austenitic alloy steel tubes.
ASTM A554	Welded stainless steel mechanical tubing.
ASTM A791/A791M	Welded unannealed ferritic stainless steel tubing.
ASTM A789/A789M	Seamless and welded ferritic/austenitic stainless steel tubing for general service.
AS 1528, Parts 1 to 4	Tubes (stainless steel) and tube fittings for the food industry.
ASTM B674	UNS N08904 welded tube.
ASTM B677	UNS N08904 seamless pipe and tube.

Carbon and alloy steel hollow bar

Standard	Description
ASTM A519	Seamless carbon and alloy steel mechanical tubing.
ISO 2938	Hollow bars for machining.
DIN 1629	Seamless circular unalloyed steel tubes – special purposes.

Product Specifications

Carbon Steel Bar Products

Standard	Description
AS 1442	Carbon steels and carbon manganese steels – hot rolled bars and semi-finished product.
AS 1443	Carbon steels and carbon manganese steels – cold finished bars.
ASTM A576	Steel bars, carbon, hot wrought, special quality.
JIS G4051	Carbon steels for machine structural use.

Carbon Steel Pipe, Tube and Fittings

Standard	Description
ASTM A179/A179M	Seamless cold drawn low alloy steel heat exchange and condenser tubes.
API 5L	Specification for line pipe.
ASTM A53M	Black and zinc coated welded and seamless steel pipe.
ASTM A106M	Seamless carbon steel pipe for high temperature service.
ASTM A105M	Carbon steel forgings for piping application.
ASTM A234M	Piping fittings of wrought carbon steel and alloy steel for moderate and high temperature service.
BS 3799	Steel pipe fittings, screwed and socket welding for the petroleum industry.
AS/NZS 1163	Structural steel hollow sections.
AS 1074	Steel tubes and tubular for ordinary service.
BS 1387	Screwed and socketed steel tube and tubulars.
EN 10241	Steel threaded pipe fittings.
ASME B36.10M	Welded and seamless wrought steel pipe.

Grade Colour Codes

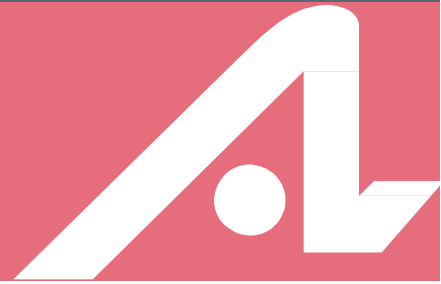

Stainless Steels		Carbon Steel		Alloy High Tensile		Alloy Case Hardening	
Grade	Colour	Grade	Colour	Grade	Colour	Grade	Colour
303	Light blue	U1004	No Colour	4140	Bluebell	8620	White
304/L	Lilac	M1010	Black	4340	Marigold	X4317	Black
316/L	Bottle Green	M1020	Custard	En 25	Jade	En 36A	Signal Red
253MA	Serpentine	M1030	White	En 26	Redgum	En 39B	Bottle Green
AtlasCR12	No Colour	1040	Golden Tan	Hytuf	Serpentine		
431	Signal Red	1045	Jade				
2205	Lime	1214	Rose Pink				
2507	Violet	12L14	Violet				

Service Centre Locations



VICTORIA

Melbourne

2/131 Calarco Drive
DERRIMUT VIC 3030
Telephone: 03 9272 9999
Facsimile: 03 9272 9950
Email: melbourne@atlassteels.com.au

Shepparton

14 McHarry Place
SHEPPARTON VIC 3630
Telephone: 03 5831 5499
Facsimile: 03 5831 7955
Email: shepparton@atlassteels.com.au

NEW SOUTH WALES

Sydney

Unit 2,1-5 Broadhurst Road
INGLEBURN NSW 2565
Telephone: 02 9825 7500
Facsimile: 02 9825 7510
Email: nswsales@atlassteels.com.au

Newcastle

1/13 Nelson Rd
CARDIFF NSW 2285
Telephone: 02 4922 5566
Facsimile: 02 4922 5565
Email: newcastle@atlassteels.com.au

TECHNICAL ASSISTANCE

Email: tech@atlassteels.com.au

QUEENSLAND

Brisbane

1302 Boundary Road
WACOL QLD 4076
Telephone: 07 3246 9999
Facsimile: 07 3246 9966
Email: brisbane@atlassteels.com.au

Mackay

42A Commercial Avenue
PAGET QLD 4740
Telephone: 07 4842 8000
Facsimile: 07 4952 3378
Email: mackay@atlassteels.com.au

SOUTH AUSTRALIA

Adelaide

425-431 Grand Junction Road
WINGFIELD SA 5013
Telephone: 08 8359 1100
Email: adelaide@atlassteels.com.au

TASMANIA

Launceston

2-4 Derby Street
MOWBRAY TAS 7248
Telephone: 03 6335 2700
Email: tas@atlassteels.com.au

PROJECT ENQUIRIES

Email: projects@atlassteels.com.au