

# Stainless Steel Pipe, Fittings & Flanges

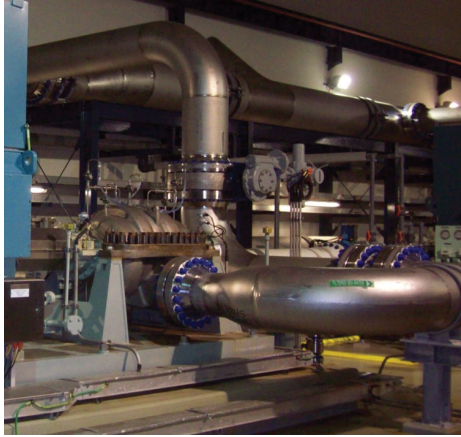

3 Stainless Steel Pipe, Fittings & Flanges



3

**A stainless steel pipe system is the product of choice for carrying corrosive or sanitary fluids, slurries and gases, particularly where high pressures, high temperatures or corrosive environments are involved. Due to stainless steel's aesthetic properties, stainless steel pipe is also used in architectural applications.**

Stainless steel pipe can be generally defined as a heavy wall thickness tubing, with dimensions as specified by the American National Standards Institute (ANSI). Pipe dimensions are specified by outside diameter – indicated by the NPS (imperial) or DN (metric) designator and sometimes confusingly referred to as the 'nominal bore' – and wall thickness, reflected in the schedule number. ASME B36.19M covers these dimensions.

Stainless steel pipe and fittings are supplied in the annealed condition to facilitate fabrication and ensure best corrosion resistance. Atlas Steels can also supply stainless steel pipe with an abrasive polished external finish suitable for architectural applications.

### **Welded Pipe**

Welded stainless steel pipe is manufactured from 2B or HRAP stainless steel strip – formed to shape, longitudinally welded and annealed.

Large size pipe is fabricated from plate.

All welds are made without the addition of filler metal, except for very large diameters.

Standard welded pipe is in nominal lengths of 6.0 or 6.1 metres.

**Manufacturing specification:** ASTM A312M – Austenitic  
ASTM A358M – Austenitic (large diameter)  
ASTM A790M – Duplex

### **Seamless Pipe**

Seamless stainless steel pipe is produced from hollow billets, which are pierced then usually cold drawn until they reach the final desired pipe size, then annealed.

Standard seamless pipe is supplied in nominal lengths of 6.1 metres to DN 150 (NPS 6) and above this in random lengths.

**Manufacturing specification:** ASTM A312M – Austenitic  
ASTM A790M – Duplex

**Stainless steel piping systems can be joined by butt welding and, in the heavier 40S and 80S schedules, by threaded connections.**

The complete piping system is made possible using complementary fittings and flanges. These are specified by the same DN or NPS designator and schedule numbering system as for pipe.



## Butt Welding Pipe Fittings

A piping system using butt welding fittings has many inherent advantages over other forms.

- Welding a fitting to the pipe means that it is permanently leak proof
- The continuous metal structure formed between pipe and fitting adds strength to the system
- Smooth inner surface and gradual direction changes reduce pressure losses and turbulence and minimise the action of corrosion and erosion
- A welded system utilizes a minimum of space

## Atlas Steels Supply Butt Welding Fittings in the following forms

- Elbows 45° and 90° – long radius is standard; short radius is also available
- Return bends 180° – long radius is standard; short radius is also available
- Reducers – concentric and eccentric
- Tees – equal and reducing
- Caps
- Stub ends – Type B, to MSS SP-43

Butt welding fittings can be supplied in either seamless or welded construction and are covered by specification ASTM A403M (or ASTM A815M for Duplex grades) and ASME B16.9.

## Screwed and Socket Weld Fittings

Piping systems can be connected using screwed fittings – BSP threaded (“150lb”) low pressure fittings and NPT threaded (class 3000) high pressure fittings in Grade 316.

Socket weld fittings are used in high pressure piping systems and are available in grade 316L to suit schedule 80S wall thickness piping.

**Manufacturing specification:** ASTM A182M (Class 3000 NPT and socket weld) and  
ASME B16.11  
ISO 4144 (BSP dimensions)

## Pipe Flanges

A flange is a ring of steel (forged, cut from plate, or rolled) designed to connect sections of pipe, or to join pipe to a pressure vessel, valve, pump or other integral flanged assembly.

Flanges are joined to each other by bolting, and are joined to the piping system by welding or threading (or loose when stub ends are used).

The basic types of flanges are:

- Slip-on
- Blind
- Weld neck
- Threaded
- Socket weld
- Lap joint
- Orifice

Forged stainless steel flanges are designed to the following common pressure ratings: Classes 150, 300, 600, 900, 1500 and 2500. Standard sealing face is Raised Face (RF).

**Manufacturing specification:** ASTM A182M and ASME B16.5.  
(Flanges over NPS24/DN 600 to ASME B16.47, API 60S or BS 3293)

Plate stainless steel flanges are forged or cut and machined from plate – Table 'D', Table 'E', etc.

**Manufacturing specification:** AS2129

Waterworks flanges to AS4087 and PN16 flanges to EN 1092-1 are also available subject to enquiry.

## Types and Applications of Flanges

**Slip-on flanges** – the flange is slipped over the pipe and then welded both inside and outside to provide sufficient strength and prevent leakage. Slip-on flanges are also used as loose back-up flanges when Type B stub ends are used.

**Blind flanges** – this is a flange without a centre bore, used to shut off a piping system or vessel opening.

**Weld neck flanges** – designed to be joined to a piping system by butt welding. They are relatively expensive due to the weld neck, but are preferred for high-stress applications.

**Lap joint flanges** – this is again similar to a slip-on flange, but has a radius at the intersection of the centre bore and the flange face to accommodate a Type A lap joint stub end. Lap joint flanges and Type A stub ends are not commonly stocked in Australia.

**Stainless Steel Pipe – Welded & Seamless – ASTM A312M / ASTM A790M**

Grades: 304/304L, 316/316L, 2205

Stainless steel pipe is available in a wide range of sizes in welded and seamless construction, ex-stock or on indent.

Nominal Pipe Size		Outside Diameter (mm)	Wall Thickness (mm)							
			Sch 5S		Sch 10S		Sch 40S		Sch 80S	
DN	NPS		WT (mm)	Weight (kg/m)	WT (mm)	Weight (kg/m)	WT (mm)	Weight (kg/m)	WT (mm)	Weight (kg/m)
6	1/8	10.3			1.24	0.28	1.73	0.37	2.41	0.47
8	1/4	13.7			1.65	0.49	2.24	0.63	3.02	0.80
10	3/8	17.1			1.65	0.63	2.31	0.84	3.20	1.10
15	1/2	21.3	1.65	0.80	2.11	1.00	2.77	1.27	3.73	1.62
20	3/4	26.7	1.65	1.02	2.11	1.28	2.87	1.69	3.91	2.20
25	1	33.4	1.65	1.29	2.77	2.09	3.38	2.50	4.55	3.24
32	1 1/4	42.2	1.65	1.65	2.77	2.69	3.56	3.39	4.85	4.47
40	1 1/2	48.3	1.65	1.90	2.77	3.11	3.68	4.05	5.08	5.41
50	2	60.3	1.65	2.39	2.77	3.93	3.91	5.44	5.54	7.48
65	2 1/2	73.0	2.11	3.69	3.05	5.26	5.16	8.63	7.01	11.41
80	3	88.9	2.11	4.52	3.05	6.46	5.49	11.29	7.62	15.27
90	3 1/2	101.6	2.11	5.18	3.05	7.41	5.74	13.57	8.08	18.64
100	4	114.3	2.11	5.84	3.05	8.37	6.02	16.08	8.56	22.32
125	5	141.3	2.77	9.46	3.40	11.56	6.55	21.77	9.53	30.97
150	6	168.3	2.77	11.31	3.40	13.83	7.11	28.26	10.97	42.56
200	8	219.1	2.77	14.78	3.76	19.97	8.18	42.55	12.70	64.64
250	10	273.1	3.40	22.61	4.19	27.79	9.27	60.31	12.70	81.56
300	12	323.9	3.96	31.25	4.57	35.99	9.53	73.88	12.70	97.47
350	14	355.6	3.96	34.34	4.78	41.36	9.53	81.33	12.70	107.40
400	16	406.4	4.19	41.56	4.78	47.34	9.53	93.27	12.70	123.31
450	18	457	4.19	46.79	4.78	53.31	9.53	105.17	12.70	139.16
500	20	508	4.78	59.32	5.54	68.65	9.53	117.15	12.70	155.13
550	22	559	4.78	65.33	5.54	75.62				
600	24	610	5.54	82.58	6.35	94.53	9.53	141.12	12.70	187.07
650	26	660								
700	28	711								
750	30	762	6.35	118.34	7.92	147.29				

- Stainless steel pipe nominal dimensions listed in the table are based on ASTM A312M and ASME B36.19M.
- These dimensions are nominal – substantial tolerances apply – refer to Atlas Steels *TechNote 12* and the ASTM and ASME standards for details.
- For other wall thicknesses and larger sizes consult ASME B36.10M; stainless steel pipe may be available to these carbon steel pipe sizes.



## Welded Butt Welding Fittings – ASTM A403M &amp; ASME B16.9



Product range and theoretical weights (kg)										
DN	Schedule 10S					Schedule 40S				
	90° Elbow	45° Elbow	Equal tee	Stub end type B	End cap	90° Elbow	45° Elbow	Equal tee	Stub end type B	End cap
15	0.06	0.03	0.09	0.07	0.03	0.08	0.04	0.10	0.08	0.04
20	0.07	0.03	0.13	0.09	0.05	0.08	0.04	0.17	0.11	0.07
25	0.14	0.08	0.28	0.16	0.08	0.15	0.11	0.29	0.17	0.10
32	0.23	0.11	0.49	0.22	0.10	0.26	0.17	0.59	0.25	0.18
40	0.30	0.17	0.68	0.25	0.11	0.40	0.23	0.86	0.31	0.20
50	0.50	0.25	0.85	0.43	0.13	0.70	0.40	1.28	0.61	0.23
65	0.85	0.48	1.41	0.57	0.19	1.40	0.77	2.19	0.80	0.27
80	1.25	0.63	1.77	0.72	0.25	2.20	1.08	3.31	1.13	0.42
100	2.10	1.08	3.46	1.09	0.68	4.47	1.47	5.27	1.87	1.14
125	3.65	1.82	5.44	1.47	1.11	6.80	2.84	9.63	2.79	2.13
150	5.45	2.72	8.03	2.15	1.42	10.89	5.44	10.99	3.57	3.23
200	10.20	5.33	15.65	3.22	2.38	21.54	10.77	20.91	6.07	5.19
250	18.15	9.75	26.76	5.13	4.45	38.56	19.27	35.38	10.07	9.00
300	25.80	13.62	39.46	8.16	7.50	59.42	29.71	62.14	14.29	15.00
350	36.29	18.37	48.53	10.88	8.17	79.38	35.15	79.31	17.14	16.00
400	47.63	23.81	58.97	12.70	10.67	99.79	45.81	99.79	20.41	21.00
450	59.87	29.94	79.65	17.23	13.00	129.73	59.40	129.73	27.21	26.00
500	99.80	49.90	103.42	21.77	17.00	162.38	74.84	162.39	29.94	34.00
600	140.61	70.31	155.58	27.21	26.00	225.89	105.23	225.90	38.55	52.00

Grades: Butt welding fittings are usually supplied as dual certified 304/304L or 316/316L

## Welded Butt Welding Fittings – ASTM A403M &amp; ASME B16.9



Product range and theoretical weights (kg)						
DN	Schedule 10S			Schedule 40S		
	Con reducer	Ecc reducer	Reducing tee	Con reducer	Ecc reducer	Reducing tee
20x15	0.10	0.10	0.11	0.14	0.14	0.15
25x15	0.12	0.12	0.25	0.15	0.15	0.26
25x20	0.13	0.13	0.25	0.16	0.16	0.27
32x20	0.18	0.18	0.44	0.22	0.22	0.52
32x25	0.18	0.18	0.45	0.22	0.22	0.53
40x20	0.18	0.18	0.58	0.24	0.24	0.74
40x25	0.19	0.19	0.60	0.26	0.26	0.76
40x32	0.21	0.24	0.61	0.28	0.28	0.77
50x25	0.28	0.28	0.73	0.40	0.40	1.10
50x32	0.30	0.30	0.74	0.44	0.44	1.13
50x40	0.31	0.31	0.76	0.45	0.45	1.15
65x40	0.44	0.44	1.24	0.76	0.76	1.94
65x50	0.47	0.47	1.25	0.80	0.80	1.98
80x40	0.51	0.51	1.52	0.94	0.94	2.85
80x50	0.55	0.55	1.56	1.00	1.00	2.91
80x65	0.59	0.59	1.59	1.08	1.08	2.98
100x40	0.68	0.68	2.90	1.36	1.36	4.53
100x50	0.78	0.78	2.94	1.57	1.57	4.48
100x65	0.83	0.83	2.97	1.66	1.66	4.54
100x80	0.87	0.87	3.04	1.74	1.74	4.64
125x100	1.49	1.49	5.49	2.98	2.98	8.47
150x80	1.82	1.82	6.86	3.98	3.98	11.94
150x100	1.96	1.96	7.10	4.07	4.07	9.68
150x125	2.00	2.00	7.27	4.07	4.07	9.99
200x100	3.01	3.01	13.46	6.55	6.55	17.98
200x150	3.19	3.19	14.08	6.94	6.94	18.82
250x100	4.73	4.73	22.75	10.52	10.52	30.07
250x150	5.00	5.00	23.55	11.12	11.12	31.13
250x200	5.20	5.20	24.08	11.56	11.56	31.84
300x200	7.67	7.67	34.73	15.98	15.98	54.43
300x250	7.98	7.98	35.52	16.63	16.63	55.79
350x300	15.29	15.29	43.96	30.58	30.58	71.21
400x200	16.70	16.70	49.90	33.40	33.40	84.82
400x250	17.22	17.22	50.80	35.43	35.43	85.73
400x300	18.35	18.35	51.71	36.70	36.70	87.54

Grades: Butt Welding Fittings are usually supplied as dual certified 304/304L or 316/316L

**Seamless Butt Welding Fittings – ASTM A403M & ASME B16.9**

Product range and theoretical weights (kg)									
DN	Schedule 10S			Schedule 40S			Schedule 80S		
	90° Elbow	45° Elbow	Equal tee	90° Elbow	45° Elbow	Equal tee	90° Elbow	45° Elbow	Equal tee
8	0.02	0.01	0.03	0.03	0.02	0.06	0.04	0.03	0.07
10	0.03	0.02	0.05	0.03	0.02	0.03	0.06	0.04	0.09
15	0.06	0.03	0.09	0.08	0.04	0.10	0.10	0.05	0.14
20	0.07	0.03	0.13	0.08	0.04	0.17	0.11	0.05	0.20
25	0.14	0.08	0.28	0.15	0.11	0.29	0.22	0.14	0.38
32	0.23	0.11	0.49	0.26	0.17	0.59	0.40	0.23	0.68
40	0.30	0.17	0.68	0.40	0.23	0.86	0.51	0.29	1.02
50	0.50	0.25	0.85	0.70	0.4	1.28	0.91	0.59	1.59
65	0.85	0.48	1.41	1.40	0.77	2.19	1.81	0.99	3.13
80	1.25	0.63	1.77	2.20	1.08	3.31	2.97	1.50	4.45
90	1.70	0.75	2.67	2.83	1.42	4.08	4.00	2.00	5.44
100	2.10	1.08	3.46	4.47	2.09	5.27	6.18	2.81	7.71
150	5.45	2.72	8.07	10.89	5.44	10.99	16.32	8.16	13.61
200	10.20	5.33	15.65	21.54	10.77	20.91	33.11	16.56	28.12
250	18.15	9.75	26.46	38.56	19.27	35.38	51.71	25.86	49.90
300	25.80	13.62	39.46	59.42	29.71	62.14	79.38	39.69	83.91

**Seamless Butt Welding Fittings – ASTM A403 & ASME B16.9**

Product range and theoretical weights (kg)									
DN	Schedule 10S			Schedule 40S			Schedule 80S		
	Con reducer	Ecc reducer	Reducing tee	Con reducer	Ecc reducer	Reducing tee	Con reducer	Ecc reducer	Reducing tee
40x.25	0.19	0.19	0.60	0.26	0.26	0.76	0.34	0.34	0.90
50x25	0.28	0.28	0.73	0.40	0.40	1.10	0.54	0.54	1.37
50x40	0.31	0.31	0.76	0.45	0.45	1.15	0.59	0.59	1.43
80x.50	0.55	0.55	1.56	1.00	1.00	2.91	1.79	1.79	3.91
100x50	0.78	0.78	2.94	1.50	1.50	4.48	1.95	1.95	6.55
100x80	0.87	0.87	3.04	1.74	1.74	4.64	2.33	2.33	6.79
150x80	1.82	1.82	6.86	3.95	3.95	9.68	5.51	5.51	11.57
150x100	1.96	1.96	7.10	4.07	4.07	11.94	5.96	5.96	11.97
200x100	3.01	3.01	13.46	6.55	6.55	17.98	9.23	9.23	24.18
200x150	3.19	3.19	14.08	6.74	6.74	18.82	10.12	10.12	25.31

- Austenitic grades specified to ASTM A403M
- Duplex grades specified to ASTM A815M
- Buttwelding fittings are usually supplied as dual certified 304/304L or 316/316L
- Duplex grades 2205 and 2507 are also available in certain sizes.



### Stainless Steel Butt Welding Fittings – Dimensions

Butt Welding Fittings to ASME B16.9															
Nominal size		OD	Elbows			Returns				Caps	Reducers Note 1	Stub Ends			
			Long		Short	Long		Short				Long	Short	Radius of Fillet	Diam of Lap
			90 deg	45 deg	90 deg	O	K	O	K						
DN	NPS	D	A	B	A	O	K	O	K	E	H	F	F	R	G
15	½	21.3	38	16		76	48			25		76	51	3	35
20	¾	26.7	38	19		76	51			25	38	76	51	3	43
25	1	33.4	38	22	25	76	56	51	41	38	51	102	51	3	51
32	1¼	42.2	48	25	32	95	70	64	52	38	51	102	51	5	64
40	1½	48.3	57	29	38	114	83	76	62	38	64	102	51	6	73
50	2	60.3	76	35	51	152	106	102	81	38	76	152	64	8	92
65	2½	73.0	95	44	64	190	132	127	100	38	89	152	64	8	106
80	3	88.9	114	51	76	229	159	152	121	51	89	152	64	10	127
90	3½	101.6	133	57	89	267	184	178	140	64	102	152	76	10	140
100	4	114.3	152	64	102	305	210	203	159	64	102	152	76	11	157
125	5	141.3	190	79	127	381	262	254	197	76	127	203	76	11	185
150	6	168.3	229	95	152	457	313	305	237	89	140	203	89	13	218
200	8	219.1	305	127	203	610	414	406	313	102	152	203	102	13	270
250	10	273.0	381	159	254	762	518	508	391	127	178	254	127	13	324
300	12	323.8	457	190	305	914	619	610	467	152	203	254	152	13	381
350	14	355.6	533	222	356	1067	711	711	533	165	330	305	152	13	413
400	16	406.4	610	254	406	1219	813	813	610	178	356	305	152	13	470
450	18	457	686	286	457	1372	914	914	686	203	381	305	152	13	533
500	20	508	762	318	508	1524	1016	1016	762	229	508	305	152	13	584
550	22	559	838	343	559	1676	1118	1118	838	254	508	305	152	13	641
600	24	610	914	381	610	1829	1219	1219	914	267	508	305	152	13	692
650	26	660	991	405						267	610				
700	28	711	1067	438						267	610				
750	30	762	1143	470						267	610				
800	32	813	1219	502						267	610				
850	34	864	1295	533						267	610				
900	36	914	1372	565						267	610				
950	38	965	1448	600						305	610				
1000	40	1016	1524	632						305	610				
1050	42	1067	1600	660						305	610				
1100	44	1118	1676	695						343	610				
1150	46	1168	1753	727						343	711				
1200	48	1219	1829	759						343	711				

Note 1: Reducer dimension "H" is based on large end nominal size.

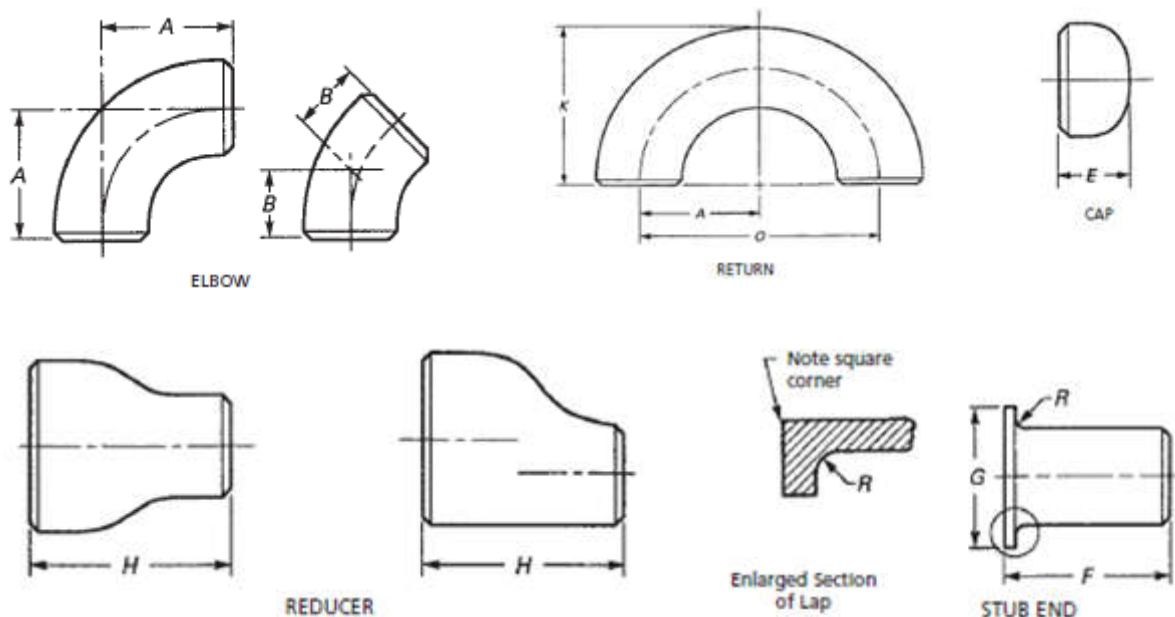

Stainless Steel Butt Welding Fittings – Dimensions

Nominal Size		Outside Diam. D	Centre to-end Run C	Centre-to-End Outlet M																																														
DN	NPS			8	10	15	20	25	32	40	50	65	80	90	100	125	150	200	250	300	350	400	450	500	550	600	650	700	750	800	850	900	950	1000	1050	1100	1150	1200												
	8	3/8	13.7																																															
	10	1/4	17.3																																															
	15	1/2	21.3	25	25																																													
	20	3/4	26.7	29	29	29																																												
	25	1	33.4			38	38	38																																										
	32	1 1/4	42.2					48	48	48																																								
	40	1 1/2	48.3	57	57	57	57																																											
	50	2	60.3			64	64	64																																										
	65	2 1/2	73.0			76	76	76	76																																									
	80	3	88.9					86	86	86																																								
	90	3 1/2	101.6						86	89	92	95																																						
	100	4	114.3						86	89	95	102	105																																					
	125	5	141.3						105	108	111	114	117	124																																				
	150	6	168.3						121	124	127	130	137	143																																				
	200	8	219.1							152	156	162	168	178																																				
	250	10	273.0							184	191	194	203	216																																				
	300	12	323.8							216	219	229	241	254																																				
	350	14	355.6							238	248	257	270	279																																				
	400	16	406.4							264	273	283	295	305	305																																			
	450	18	457								298	308	321	330	330	343																																		
	500	20	508								324	333	346	356	356	368	381																																	
	550	22	559								359	371	381	394	394	406	419																																	
	600	24	610								364	397	406	406	419	432	432																																	
	650	26	660									422	432	444	457	470	483	495																																
	700	28	711									448	457	470	483	495	508	521	521																															
	750	30	762								460	473	483	495	508	521	533	546	546	559																														
	800	32	813										508	508	521	533	546	559	572	572	584	597																												
	850	34	864										533	546	559	572	584	597	597	610	622	635																												
	900	36	914										559	572	584	597	610	622	622	635	648	660	673																											
	950	38	965											597	610	622	635	648	648	673	686	698	711	711																										
	1000	40	1016											622	635	648	660	673	673	698	711	724	737	749	749																									
	1050	42	1067											635	648	660	660	698	698	711	711	711	711	711	711																									
	1100	44	1118											686	698	698	711	711	724	724	737	749	749	762	762																									
	1150	46	1168											724	724	737	737	749	749	762	762	775	787	800	800																									
	1200	48	1219											737	737	762	762	787	787	813	813	813	813	838	838																									

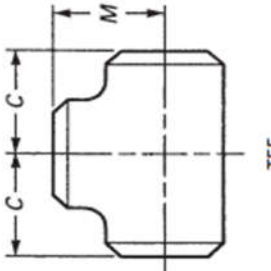
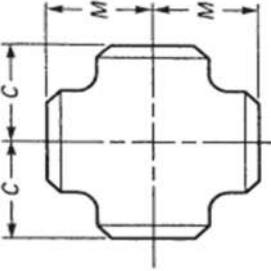

### Stainless Steel ASME/ANSI Flanges – Dimensions & Weights

These diagrams relate to the tables of flange specified dimensions on the following pages.

The Notes shown on this page also relate to the tables on the following pages.

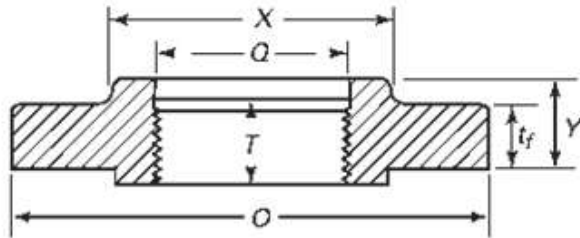

Threaded

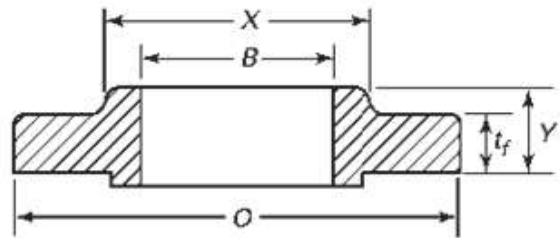

Slip-On Welding

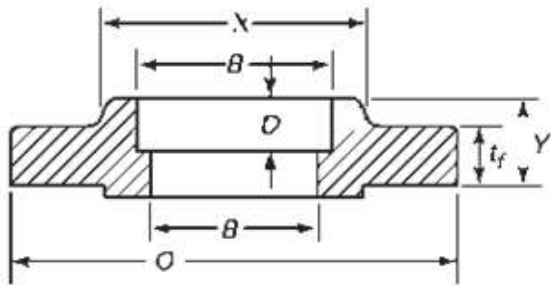

Socket Welding

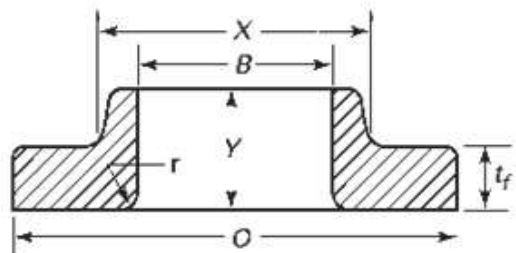

Lapped

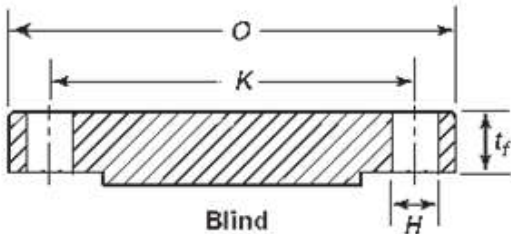

Blind

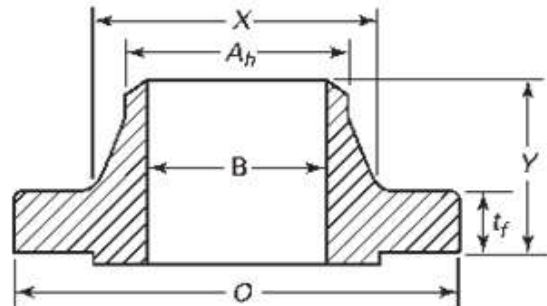

Welding Neck

Note 1: To be specified by purchase

Note 2: Flange weights are approximate

Note 3: Welding neck flange bore sizes listed are for sch 40S / Standard Wall pipe

**Common stock items are –**

- Slip-On Welding
- Welding Neck
- Blind



### Stainless Steel ASME/ANSI Flanges – Dimensions & Weights

Class 150 Flanges to ASME B16.5																	
Nominal Size		Dimensions													Flange Weight (kg)		
DN	NPS	Flange OD (mm) O	Thick-ness min (mm) t <sub>f</sub>	Hub Diam. (mm) X	Hub Diam. Welding Neck (mm) A <sub>n</sub>	Length Thru Hub		Bore		Bolt Drilling					Slip-on	Welding Neck	Blind
						Slip-on/Socket Welding (mm) Y	Welding Neck (mm) Y	Slip-on/Socket Welding min (mm) B	Welding Neck / Socket Welding (mm) B	Circle Diam. (mm) K	Hole Diam. (mm) H	Bolts (No.)	RF Stud Bolt Length (mm)	RF Machine Bolt Length (mm)			
15	½	90	9.6	30	21.3	14	46	22.2	15.8	60.3	15.9	4	55	50	0.4	0.5	0.4
20	¾	100	11.2	38	26.7	14	51	27.7	20.9	69.9	15.9	4	65	50	0.6	0.7	0.6
25	1	110	12.7	49	33.4	16	54	34.5	26.6	79.4	15.9	4	65	55	0.8	1.0	0.9
32	1 ¼	115	14.3	59	42.2	19	56	43.2	35.1	88.9	15.9	4	70	55	1.0	1.3	1.2
40	1 ½	125	15.9	65	48.3	21	60	49.5	40.9	98.4	15.9	4	70	65	1.3	1.7	1.5
50	2	150	17.5	78	60.3	24	62	61.9	52.5	120.7	19.1	4	85	70	2.1	2.6	2.4
65	2 ½	180	20.7	90	73.0	27	68	76.6	62.7	139.7	19.1	4	90	75	3.3	4.1	3.9
80	3	190	22.3	108	88.9	29	68	90.7	77.9	152.4	19.1	4	90	75	3.9	4.9	4.9
90	3 ½	215	22.3	122	101.6	30	70	103.4	90.1	177.8	19.1	8	90	75	4.8	6.1	6.2
100	4	230	22.3	135	114.3	32	75	116.1	102.3	190.5	19.1	8	90	75	5.3	6.8	7.0
125	5	255	22.3	164	141.3	35	87	143.8	128.2	215.9	22.2	8	95	85	6.1	8.6	8.5
100	4	230	22.3	135	114.3	32	75	116.1	102.3	190.5	19.1	8	90	75	5.3	6.8	7.0
125	5	255	22.3	164	141.3	35	87	143.8	128.2	215.9	22.2	8	95	85	6.1	8.6	8.6
150	6	280	23.9	192	168.3	38	87	170.7	154.1	241.3	22.2	8	100	85	7.5	11	11
200	8	345	27.0	246	219.1	43	100	221.5	202.7	298.5	22.2	8	110	90	12	18	20
250	10	405	28.6	305	273.0	48	100	276.2	254.6	362.0	25.4	12	115	100	17	24	29
300	12	485	30.2	365	323.8	54	113	327.0	304.8	431.8	25.4	12	120	100	26	37	43
350	14	535	33.4	400	355.6	56	125	359.2	Note (1)	476.3	28.6	12	135	115	35	48	58
400	16	595	35.0	457	406.4	62	125	410.5	Note (1)	539.8	28.6	16	135	115	45	61	76
450	18	635	38.1	505	457.0	67	138	461.8	Note (1)	577.9	31.8	16	145	125	49	68	94
500	20	700	41.3	559	508.0	71	143	513.1	Note (1)	635.0	31.8	20	160	140	62	85	122
600	24	815	46.1	663	610.0	81	151	616.0	Note (1)	749.3	34.9	20	170	150	87	115	186

Class 300 Flanges to ASME B16.5																	
Nominal Size		Dimensions													Flange Weight (kg)		
DN	NPS	Flange OD (mm) O	Thick-ness min (mm) t <sub>f</sub>	Hub Diam. (mm) X	Hub Diam. Welding Neck (mm) A <sub>n</sub>	Length Thru Hub		Bore		Bolt Drilling					Slip-on	Welding Neck	Blind
						Slip-on/Socket Welding (mm) Y	Welding Neck (mm) Y	Slip-on/Socket Welding min (mm) B	Welding Neck / Socket Welding (mm) B	Circle Diam. (mm) K	Hole Diam. (mm) H	Bolts (No.)	RF Stud Bolt Length (mm)	RF Machine Bolt Length (mm)			
15	½	95	12.7	38	21.3	21	51	22.2	15.8	66.7	15.9	4	65	55	0.6	0.8	0.6
20	¾	115	14.3	48	26.7	24	56	27.7	20.9	82.6	19.1	4	75	65	1.2	1.3	1.2
25	1	125	15.9	54	33.4	25	60	34.5	26.6	88.9	19.1	4	75	65	1.4	1.6	1.4
32	1 ¼	135	17.5	64	42.2	25	64	43.2	35.1	98.4	19.1	4	85	70	1.7	2.1	1.8
40	1 ½	155	19.1	70	48.3	29	67	49.5	40.9	114.3	22.2	4	90	75	2.6	3.1	2.7
50	2	165	20.7	84	60.3	32	68	61.9	52.5	127.0	19.1	8	90	75	2.9	3.4	3.1
65	2 ½	190	23.9	100	73.0	37	75	74.6	62.7	149.2	22.2	8	100	85	4.5	5.3	4.8
80	3	210	27.0	117	88.9	41	78	90.7	77.9	168.3	22.2	8	110	90	6.2	7.3	6.8
90	3 ½	230	28.6	133	101.6	43	79	103.4	90.1	184.2	22.2	8	110	95		8.2	9.5
100	4	255	30.2	146	114.3	46	84	116.1	102.3	200.0	22.2	8	115	95		11	12
125	5	280	33.4	178	141.3	49	97	143.8	128.2	235.0	22.2	8	120	110		15	16
150	6	320	35.0	206	168.3	51	97	170.7	154.1	269.9	22.2	12	120	110		20	21
200	8	380	39.7	260	219.1	60	110	221.5	202.7	330.2	25.4	12	140	120		30	35
250	10	445	46.1	321	273.0	65	116	276.2	254.6	387.4	28.6	16	160	140		44	55
300	12	520	49.3	375	323.8	71	129	327.0	304.8	450.8	31.8	16	170	145		64	79
350	14	585	52.4	425	355.6	75	141	359.2	Note (1)	514.4	31.8	20	180	160		88	107
400	16	650	55.6	483	406.4	81	144	410.5	Note (1)	571.5	34.9	20	190	165		113	139
450	18	710	58.8	533	457.0	87	157	461.8	Note (1)	628.6	34.9	24	195	170		138	177
500	20	775	62.0	587	508.0	94	160	513.1	Note (1)	685.8	34.9	24	205	185		167	223
600	24	915	68.3	702	610.0	105	167	616.0	Note (1)	812.8	41.3	24	230	205		235	342

These flanges are available in a very wide range of sizes, ratings and types in 304/304L and 316/316L. Other grades such as 2205 are available subject to enquiry.

### Stainless Steel ASME/ANSI Flanges – Dimensions & Weights

Class 600 Flanges to ASME B16.5																
Nominal Size		Dimensions												Flange Weight (kg)		
DN	NPS	Flange OD (mm) O	Thick-ness min (mm) t <sub>t</sub>	Hub Diam. (mm) X	Hub Diam. Welding Neck (mm) A <sub>h</sub>	Length Thru Hub		Bore		Bolt Drilling				Slip-on	Welding Neck	Blind
						Slip-on/Socket Welding (mm) Y	Welding Neck (mm) Y	Slip-on/Socket Welding min (mm) B	Welding Neck / Socket Welding (mm) B	Circle Diam. (mm) K	Hole Diam. (mm) H	Bolts (No.)	RF Stud Bolt Length (mm)			
15	½	95	14.3	38	21.3	22	52	22.2	Note (1)	66.7	15.9	4	75	0.9	0.9	0.9
20	¾	115	15.9	48	26.7	25	57	27.7	Note (1)	82.6	19.1	4	90	1.4	1.6	1.4
25	1	125	17.5	54	33.4	27	62	34.5	Note (1)	88.9	19.1	4	90	1.8	1.9	1.8
32	1 ¼	135	20.7	64	42.2	29	67	43.2	Note (1)	98.4	19.1	4	95	2.6	2.5	2.4
40	1 ½	155	22.3	70	48.3	32	70	49.5	Note (1)	114.3	22.2	4	110	3.2	3.6	3.4
50	2	165	25.4	84	60.3	37	73	61.9	Note (1)	127.0	19.1	8	110	3.9	4.5	4.4
65	2 ½	190	28.6	100	73.0	41	79	74.6	Note (1)	149.2	22.2	8	120	5.9	6.4	6.8
80	3	210	31.8	117	88.9	46	83	90.7	Note (1)	168.3	22.2	8	125	7.4	8.1	8.9
90	3 ½	230	35.0	133	101.6	49	86	103.4	Note (1)	184.	25.4	8	140		12	13
100	4	275	38.1	152	114.3	54	102	116.1	Note (1)	215.9	25.4	8	145		17	19
125	5	330	44.5	189	141.3	60	114	143.8	Note (1)	266.7	28.6	8	165		31	31
150	6	355	47.7	222	168.3	67	117	170.7	Note (1)	292.1	28.6	12	170		37	38
200	8	420	55.6	273	219.1	76	133	221.5	Note (1)	349.2	31.8	12	190		51	62
250	10	510	63.5	343	273.0	86	152	276.2	Note (1)	431.8	34.9	16	215		86	102
300	12	560	66.7	400	323.8	92	156	327.0	Note (1)	489.0	34.9	20	220		103	132
350	14	605	69.9	432	355.6	94	165	359.2	Note (1)	527.0	38.1	20	235		122	158
400	16	685	76.2	495	406.4	106	178	410.5	Note (1)	603.2	41.3	20	255		177	225
450	18	745	82.6	546	457.0	117	184	461.8	Note (1)	654.0	44.5	20	275		216	285
500	20	815	88.9	610	508.0	127	190	513.1	Note (1)	723.9	44.5	24	285		268	365
600	24	940	101.6	718	610.0	140	203	616.0	Note (1)	838.2	50.8	24	330		372	533

Class 900 Flanges to ASME B16.5																
Nominal Size		Dimensions												Flange Weight (kg)		
DN	NPS	Flange OD (mm) O	Thick-ness min (mm) t <sub>t</sub>	Hub Diam. (mm) X	Hub Diam. Welding Neck (mm) A <sub>h</sub>	Length Thru Hub		Bore		Bolt Drilling				Slip-on	Welding Neck	Blind
						Slip-on/Socket Welding (mm) Y	Welding Neck (mm) Y	Slip-on/Socket Welding min (mm) B	Welding Neck / Socket Welding (mm) B	Circle Diam. (mm) K	Hole Diam. (mm) H	Bolts (No.)	RF Stud Bolt Length (mm)			
15	½	120	22.3	38	21.3	32	60	22.2	Note (1)	82.6	22.2	4	110	1.8	2.1	1.9
20	¾	130	25.4	44	26.7	35	70	27.7	Note (1)	88.9	22.2	4	115	2.3	2.7	2.7
25	1	150	28.6	52	33.4	41	73	34.5	Note (1)	101.6	25.4	4	125	3.4	3.9	4.1
32	1 ¼	160	28.6	64	42.2	41	73	43.2	Note (1)	111.1	25.4	4	125	4.1	4.5	4.3
40	1 ½	180	31.8	70	48.3	44	83	49.5	Note (1)	123.8	28.6	4	140	5.5	5.9	5.9
50	2	215	38.1	105	60.3	57	102	61.9	Note (1)	165.1	25.4	8	145	11	11	11
65	2 ½	245	41.3	124	73.0	64	105	74.6	Note (1)	190.5	28.6	8	160	16	16	16
80	3	240	38.1	127	88.9	54	102	90.7	Note (1)	190.5	25.4	8	145	12	15	13
100	4	290	44.5	159	114.3	70	114	116.1	Note (1)	235.0	31.8	8	170	23	23	25
125	5	350	50.8	190	141.3	79	127	143.8	Note (1)	279.4	34.9	8	190	38	39	39
150	6	380	55.6	235	168.3	86	140	170.7	Note (1)	317.5	31.8	12	190	48	50	52
200	8	470	63.5	298	219.1	102	162	221.5	Note (1)	393.7	38.1	12	220	75	79	59
250	10	545	39.9	368	273.0	108	184	276.2	Note (1)	469.9	38.1	16	235	111	118	132
300	12	610	79.4	419	323.8	117	200	327.0	Note (1)	533.4	38.1	20	255	146	157	187
350	14	640	85.8	451	355.6	130	213	359.2	Note (1)	558.8	41.3	20	275	172	182	224
400	16	705	88.9	508	406.4	133	216	410.5	Note (1)	616.0	44.5	20	285	193	225	272
450	18	785	101.6	565	457.0	152	229	461.8	Note (1)	685.8	50.8	20	325	272	309	386
500	20	855	108.0	622	508.0	159	248	513.1	Note (1)	749.3	54.0	20	350	331	377	488
600	24	1040	139.7	749	610.0	203	292	616.0	Note (1)	901.7	66.7	20	440	632	685	905

These flanges are available in a very wide range of sizes, ratings and types in 304/304L and 316/316L. Other grades such as 2205 are available subject to enquiry.

### Stainless Steel ASME/ANSI Flanges – Dimensions & Weights

Class 1500 Flanges to ASME B16.5																
Nominal Size		Dimensions												Flange Weight (kg)		
DN	NPS	Flange OD (mm) O	Thick-ness min (mm) $t_r$	Hub Diam. (mm) X	Hub Diam. Welding Neck (mm) $A_h$	Length Thru Hub		Bore		Bolt Drilling				Slip-on	Welding Neck	Blind
						Slip-on/Socket Welding (mm) Y	Welding Neck (mm) Y	Slip-on/Socket Welding min (mm) B	Welding Neck / Socket Welding (mm) B	Circle Diam. (mm) K	Hole Diam. (mm) H	Bolts (No.)	RF Stud Bolt Length (mm)			
15	½	120	22.3	38	21.3	32	60	22.2	Note (1)	82.6	22.2	4	110	1.8	2.1	1.9
20	¾	130	25.4	44	26.7	35	70	27.7	Note (1)	88.9	22.2	4	115	2.8	2.7	2.7
25	1	150	28.6	52	33.4	41	73	34.5	Note (1)	101.6	25.4	4	125	3.6	3.9	4.1
32	1 ¼	160	28.6	64	42.2	41	73	43.2	Note (1)	111.1	25.4	4	125	5.0	4.5	4.3
40	1 ½	180	31.8	70	48.3	44	83	49.5	Note (1)	123.8	28.6	4	140	6.8	5.9	5.9
50	2	215	38.1	105	60.3	57	102	61.9	Note (1)	165.1	25.4	8	145	11	11	11
65	2 ½	245	41.3	124	73.0	64	105	74.6	Note (1)	190.5	28.6	8	160	16	16	16
80	3	265	47.7	133	88.9		117		Note (1)	203.2	31.8	8	180		22	22
100	4	310	54.0	162	114.3		124		Note (1)	241.3	34.9	8	195		31	33
125	5	375	73.1	197	141.3		156		Note (1)	292.1	41.3	8	250		59	60
150	6	395	82.6	229	168.3		171		Note (1)	317.5	38.1	12	260		75	75
200	8	485	92.1	292	219.1		213		Note (1)	393.7	44.5	12	290		124	137
250	10	585	108.0	368	273.0		254		Note (1)	482.6	50.8	12	335		206	230
300	12	675	123.9	451	323.8		283		Note (1)	571.5	54.0	16	375		306	316
350	14	750	133.4	495	355.6		298		Note (1)	635.0	60.3	16	405		416	421
400	16	825	146.1	552	406.4		311		Note (1)	704.8	66.7	16	445		568	559
450	18	915	162.0	597	457.0		327		Note (1)	774.7	73.0	16	495		736	761
500	20	985	177.8	641	508.0		356		Note (1)	831.8	79.4	16	540		929	967
600	24	1170	203.2	762	610.0		406		Note (1)	990.6	92.1	16	615		1504	1568

Class 2500 Flanges to ASME B16.5																
Nominal Size		Dimensions												Flange Weight (kg)		
DN	NPS	Flange OD (mm) O	Thick-ness min (mm) $t_r$	Hub Diam. (mm) X	Hub Diam. Welding Neck (mm) $A_h$	Length Thru Hub		Bore		Bolt Drilling				Slip-on	Welding Neck	Blind
						Slip-on/Socket Welding (mm) Y	Welding Neck (mm) Y	Slip-on/Socket Welding min (mm) B	Welding Neck / Socket Welding (mm) B	Circle Diam. (mm) K	Hole Diam. (mm) H	Bolts (No.)	RF Stud Bolt Length (mm)			
15	½	135	30.2	43	21.3	40	73	22.9	Note (1)	88.9	22.2	4	120	3.0	3.2	3.2
20	¾	140	31.8	51	26.7	43	79	28.2	Note (1)	95.2	22.2	4	125	3.6	4.1	4.5
25	1	160	35.0	57	33.4	48	89	34.9	Note (1)	108.0	25.4	4	140	5.0	5.5	5.4
32	1 ¼	185	38.1	73	42.2	52	95	43.7	Note (1)	130.2	28.6	4	150	7.3	9.1	8.2
40	1 ½	205	44.5	79	48.3	60	111	50.0	Note (1)	146.0	31.8	4	170	10	11	10
50	2	235	50.9	95	60.3	70	127	62.5	Note (1)	171.4	28.6	8	180	17	19	18
65	2 ½	265	57.2	114	73.0	79	143	75.4	Note (1)	196.8	31.8	8	195	24	24	25
80	3	305	66.7	133	88.9	92	168	91.4	Note (1)	228.6	34.9	8	220	36	43	39
100	4	355	76.2	165	114.3	108	190	116.8	Note (1)	273.0	41.3	8	255	54	64	60
125	5	420	92.1	203	141.3	130	229	144.4	Note (1)	323.8	47.6	8	300	93	111	101
150	6	485	108.0	235	168.3	152	273	171.4	Note (1)	368.3	54.0	8	345	143	176	157
200	8	550	127.0	305	219.1	178	318	222.2	Note (1)	438.2	54.0	12	380	213	261	241
250	10	675	165.1	375	273.0	229	419	277.4	Note (1)	539.8	66.7	12	490	409	484	465
300	12	760	184.2	441	323.8	254	464	328.2	Note (1)	619.1	73.0	12	540	573	692	664

These flanges are available in a very wide range of sizes, ratings and types in 304/304L and 316/316L. Other grades such as 2205 are available subject to enquiry.



## Stainless Steel Table Flanges – Dimensions & Weights

These diagrams relate to the tables of flange specified dimensions on the following pages. Refer note below regarding terminology of Table flange types.

### Types of Table Flanges specified in AS 2129, AS 4087 & EN 1092

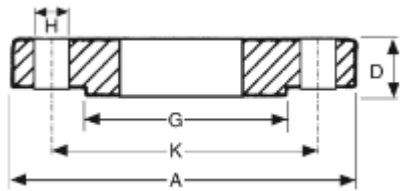
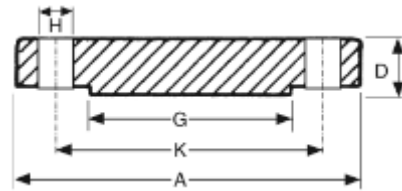
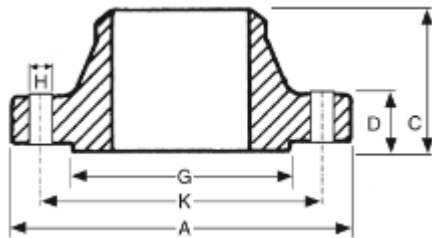

PLATE  
"SLIP-ON WELDING"



BLIND  
("BLANK")



WELDING NECK (WN)

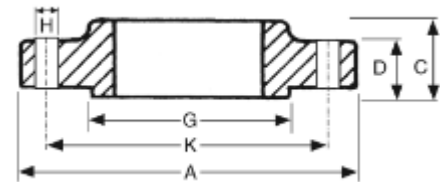

BOSS

#### Notes to these diagrams and the following tables of dimensions.

- Diagrams above show the optional Raised Face.
- Standard Atlas Steels Table Flange stock is Flat Faced.
- All weights are approximate
- A diametrical clearance of 4mm maximum applies to pipe or tube OD for plate flanges
- The flange thickness "D" dimension includes the raised face height, if a non-standard raised sealing face is present.
- Welding Neck bore is derived from the pipe schedule
- Atlas standard stock table flanges are plate and blind type. Note that AS2129 plate flanges are usually referred to by end users as "slip-on welding" flanges and this terminology is also used in Atlas product descriptions.
- PN16 "DIN" flanges to EN1092-1 and AS4087 waterworks flanges are also available subject to enquiry.

## Stainless Steel Table Flanges – Dimensions &amp; Weights

Nominal Size	Dimensions (mm)							Weight (kg)	
	DN	OD A	Thickness D	Raised Face Diam. G	Drilling			Bolt Size & Thread	SOW
Bolt Circle Diam. K					Bolt Hole Diam. H	Number of Bolts			
15	95	*5	47	67	14	4	M12	0.6	0.6
20	100	*5	53	73	14	4	M12	0.7	0.7
25	115	*5	65	83	14	4	M12	0.9	1.0
32	120	*6	67	87	14	4	M12	0.9	1.1
40	135	*6	78	98	14	4	M12	1.2	1.4
50	150	*8	90	114	18	4	M16	1.4	1.7
65	165	*8	103	127	18	4	M16	1.6	2.1
80	185	*10	122	146	18	4	M16	2.0	2.7
90	205	*10	141	165	18	4	M16	2.2	3.2
100	215	*10	154	178	18	4	M16	2.5	3.6
125	255	13	186	210	18	8	M16	3.3	4.9
150	280	13	211	235	18	8	M16	4.0	6.1
200	335	13	268	292	18	8	M16	5.0	8.8
250	405	16	328	356	22	8	M20	8.7	15.8
300	455	19	378	406	22	12	M20	11.3	23.6
350	525	22	438	470	26	12	M24	19.6	38.6
400	580	22	489	521	26	12	M24	22.3	44.9
450	640	25	532	584	26	12	M24	29.0	63.0
500	705	29	609	641	26	16	M24	39.9	86.0
550	760	29	637	699	30	16	M27	50.0	107.0
600	825	32	720	756	30	16	M27	58.0	125.0
700	910	35	809	845	30	20	M27		
750	995	41	888	927	33	20	M30		
800	1060	41	942	984	36	20	M33		
850	1090	44	974	1016	36	20	M33		
900	1175	48	1050	1092	36	24	M33		
1000	1255	51	1133	1175	36	24	M33		
1200	1490	60	1368	1410	36	32	M33		

Nominal Size	Dimensions (mm)							Weight (kg)	
	DN	OD A	Thickness D	Raised Face Diam. G	Drilling			Bolt Size & Thread	SOW
Bolt Circle Diam. K					Bolt Hole Diam. H	Number of Bolts			
15	95	*6	47	67	14	4	M12	0.6	0.7
20	100	*6	53	73	14	4	M12	0.7	0.8
25	115	*7	63	83	14	4	M12	0.9	1.0
32	120	*8	67	87	14	4	M12	1.0	1.1
40	135	*9	78	98	14	4	M12	1.2	1.4
50	150	*10	90	114	18	4	M16	1.4	1.7
65	165	*10	103	127	18	4	M16	1.6	2.1
80	185	*11	122	146	18	4	M16	2.0	2.7
90	205	12	141	165	18	8	M16		
100	215	13	154	178	18	8	M16	2.5	3.6
125	255	14	186	210	18	8	M16	3.7	5.5
150	280	17	207	235	22	8	M20	5.0	8.3
200	335	19	264	292	22	8	M20	7.1	12.9
250	405	22	328	356	22	12	M20	11.4	21.9
300	455	25	374	406	26	12	M24	15.1	31.8
350	525	29	438	470	26	12	M24	25.3	47.6
400	580	32	489	521	26	12	M24	31.3	66.0
450	640	35	552	584	26	16	M24	40.8	87.0
500	705	38	609	641	26	16	M24	53.0	114.0
550	760	44	663	699	30	16	M27		
600	825	48	717	756	33	16	M30	85.0	195.0
700	910	51	806	845	33	20	M30		
750	995	54	885	927	36	20	M33		
800	1060	54	942	984	36	20	M33		
850	1090	57	974	1016	36	20	M33		
900	1175	64	1050	1092	36	24	M33		
1000	1255	67	1130	1175	39	24	M36		
1200	1490	79	1365	1410	39	32	M36		

## Stainless Steel Table Flanges – Dimensions &amp; Weights

Nominal Size	Dimensions (mm)							Weight (kg)		
	DN	OD A	Thickness D	Raised Face Diam. G	Drilling			Bolt Size & Thread	SOW	Blind
					Bolt Circle Diam. K	Bolt Hole Diam. H	Number of Bolts			
15	95	10	47	67	14	4	M12	0.6	0.7	
20	100	10	53	73	14	4	M12	0.7	0.8	
25	120	10	63	87	18	4	M16	0.9	1.0	
32	135	13	74	98	18	4	M16	1.1	1.3	
40	140	13	81	105	18	4	M16	1.2	1.4	
50	165	16	103	127	18	4	M16	2.2	2.6	
65	185	16	122	146	18	4	M16	2.5	3.0	
80	205	16	141	165	18	8	M16	3.0	3.8	
90	215	19	154	178	18	8	M16			
100	230	19	167	191	18	8	M16	4.3	5.9	
125	280	22	207	235	22	8	M20	7.4	10.1	
150	305	22	232	260	22	12	M20	8.1	11.9	
200	370	35	296	324	22	12	M20	12.7	20.3	
250	430	29	349	381	26	12	M24	18.1	31.4	
300	490	32	406	438	26	16	M24	23.9	44.7	
350	550	35	459	495	30	16	M27	35.3	63.0	
400	610	41	516	552	30	20	M27	47.6	90.0	
450	675	44	571	610	33	20	M30	62.0	120.0	
500	735	51	634	673	33	24	M30	80.0	162.0	
550	785	54	685	724	33	24	M30			
600	850	57	739	781	36	24	M33	112.0		
700	935	60	815	857	36	24	M33			
750	1015	67	898	940	36	28	M33			
800	1060	68	942	984	36	28	M33			
850	1090	70	974	1016	36	32	M33			
900	1185	76	1060	1105	39	32	M36			
1000	1275	83	1149	1194	39	36	M36			
1200	1530	95	1385	1441	42	40	M39			

Nominal Size	Dimensions (mm)							Weight (kg)		
	DN	OD A	Thickness D	Raised Face Diam. G	Drilling			Bolt Size & Thread	SOW	Blind
					Bolt Circle Diam. K	Bolt Hole Diam. H	Number of Bolts			
15	115	57	57	83	18	4	M16	0.8	1.0	
20	115	57	57	83	18	4	M16	0.9	1.0	
25	120	64	64	87	18	4	M16	1.1	1.2	
32	135	76	76	98	18	4	M16	1.5	1.8	
40	140	83	83	105	18	4	M16	1.7	2.0	
50	165	102	102	127	18	4	M16	2.6	3.1	
65	185	114	114	146	18	8	M16	3.1	3.8	
80	205	127	127	165	18	8	M16	4.3	5.4	
90	215	140	140	178	18	8	M16			
100	230	152	152	191	18	8	M16	5.8	7.9	
125	280	178	178	235	22	8	M20	9.9	12.6	
150	305	210	210	260	22	12	M20	10.8	15.4	
200	370	260	260	324	22	12	M20	18.3	28.2	
250	430	311	311	381	26	12	M24	22.1	38.0	
300	490	362	362	438	26	16	M24	31.0	58.0	
350	550	419	419	495	30	16	M27	47.7	85.0	
400	610	483	483	552	30	20	M27	62.0	118.0	
450	675	533	533	610	33	20	M30	105.0	196.0	
500	735	597	597	673	33	24	M30			
550	785	648	648	724	33	24	M30			
600	850	699	699	781	36	24	M33			

## Stainless Steel Pipe, Fittings &amp; Flanges



PN16 Flanges to AS 4087								
Nominal Size DN	Dimensions							Bolt Size & thread
	OD A	Raised Face Height	Raised Face Diam G	Thickness D	Bolt Circle Diam K	Number of Holes	Hole Diameter H	
50	150	3	90	11	114	4	18	M16
65	165	3	103	11	127	4	18	M16
80	185	3	122	11	146	4	18	M16
100	215	3	154	13	178	4	18	M16
150	280	3	211	13	235	8	18	M16
165	280	3	211	13	235	8	18	M16
200	335	3	268	19	292	8	18	M16
225	370	3	300	19	324	8	18	M16
250	405	3	328	19	356	8	22	M20
300	455	4	378	23	406	12	22	M20
350	525	4	438	30	470	12	26	M24
375	550	4	463	30	495	12	26	M24
400	580	4	489	30	521	12	26	M24
450	640	4	552	30	584	12	26	M245
500	705	4	609	38	641	16	26	M24
600	825	5	720	48	756	16	30	M27
700	910	5	809	56	845	20	30	M27
750	995	5	888	56	927	20	33	M30
800	1060	5	942	56	984	20	36	M33
900	1175	5	1050	66	1092	24	36	M33
1000	1255	5	1133	66	1175	24	36	M33
1200	1490	5	1368	76	1410	32	36	M33

PN16 Flanges to EN 1092									
Nominal Size DN	Dimensions								Bolt Size & thread
	OD A	Raised Face Height	Raised Face Diam G	Thickness Blind	Thickness SOW D	Bolt Circle Diam K	Number of Holes	Hole Diameter H	
15	95.0	2	45	16	14	65	4	14	M12
20	105.0	2	58	18	16	75	4	14	M12
25	115	2	68	18	16	85	4	18	M12
32	140	2	78	18	18	100	4	18	M16
40	150	3	88	18	18	110	4	18	M16
50	165	3	102	18	20	125	4	18	M16
65	185	3	122	18	20	145	8	18	M16
80	200	3	138	20	20	160	8	18	M16
100	220	3	158	20	22	180	8	18	M16
125	250	3	188	22	22	210	8	18	M16
150	285	3	212	22	24	240	8	22	M20
165	285	3	212	22	24	240	8	22	M20
200	340	3	268	24	26	295	12	22	M20
250	405	3	320	26	29	355	12	26	M24
300	460	4	378	28	32	410	12	26	M24
350	520	4	438	30	35	470	16	26	M24
400	580	4	490	32	38	525	16	30	M27
450	640	4	550	40	42	585	20	30	M27
500	715	4	610	44	46	650	20	33	M30
600	840	5	725	54	55	770	20	36	M33
700	910	5	795	58	63	840	24	36	M33
800	1025	5	900	62	74	950	24	39	M36
900	1125	5	1000	64	82	1050	28	39	M36

## Screwed Low Pressure “150lb” BSP 316 Fittings



Product range and theoretical weights (kg)												
DN	Round socket	Pipe nipple TBE	Pipe nipple TOE	Hex/round cap	Hex nipple	3 pce union	Female 90° elbow	Male/fem 90° elbow	Female tee	Hex head plug	Hex locknut	Square head plug
6	0.02	0.02	0.01	0.02	0.02	0.13	0.03	0.02	0.05	0.02	0.02	0.01
8	0.04	0.03	0.02	0.03	0.03	0.11	0.04	0.04	0.05	0.03	0.02	0.02
10	0.05	0.04	0.03	0.03	0.05	0.18	0.06	0.06	0.09	0.03	0.03	0.03
15	0.09	0.08	0.05	0.07	0.08	0.22	0.10	0.11	0.14	0.05	0.04	0.03
20	0.13	0.11	0.08	0.10	0.11	0.33	0.14	0.16	0.21	0.09	0.05	0.07
25	0.20	0.16	0.11	0.17	0.17	0.50	0.27	0.26	0.36	0.12	0.10	0.10
32	0.29	0.29	0.19	0.24	0.25	0.70	0.38	0.40	0.50	0.19	0.14	0.15
40	0.34	0.35	0.23	0.38	0.37	0.87	0.51	0.50	0.70	0.27	0.15	0.21
50	0.52	0.58	0.30	0.47	0.53	1.39	0.75	0.82	1.01	0.40	0.25	0.31
65	0.78	0.92	0.57	0.85	1.14	2.07	1.69	1.68	2.41	0.76	0.51	0.59
80	1.05	1.45	0.86	1.24	1.37	2.98	2.33	2.06	3.32	1.03	0.55	0.71
100	1.90	2.07	1.38	2.09	1.90	4.82	3.43	3.45	4.81	1.66	0.92	1.10

TBE = Threaded Both Ends

TOE = Threaded One End



## Screwed Low Pressure “150 lb” BSP 316 Fittings

**BSP Fittings**

Dimensions: generally to ISO4144.

Threading: BS21 (ISO 7-1).

Feed materials – sockets, TOE nipples, TBE nipples  
manufactured from stainless steel pipe to ASTM A312M.

- Other fittings made from investment castings.

Product range and theoretical weights (kg)		
DN	Hex reducing bush	Hex reducing nipple
8x6	0.01	0.03
10x6	0.02	0.05
10x8	0.03	0.05
15x6	0.04	0.08
15x8	0.06	0.08
15x10	0.06	0.08
20x8	0.08	0.12
20x10	0.07	0.12
20x15	0.05	0.12
25x10	0.14	0.17
25x15	0.12	0.17
25x20	0.08	0.17
32x25	0.15	0.26
40x20	0.33	0.36
40x25	0.26	0.36
40x32	0.17	0.36
50x25	0.56	0.50
50x32	0.45	0.50
50x40	0.37	0.50
65x50	0.51	0.85
80x50	0.94	1.28
80x55	1.23	1.28



## Screwed Class 3000 NPT Fittings – ASTM A182M and ASME B16.11



## Grade 316

Product range and theoretical weights (kg)												
DN	Hex cap	Coupling	45° Elbow	90° Elbow	Hex nipple	Hex plug	Union	Female tee	Schedule 40S		Schedule 80S	
									Nipple TBE	Nipple TOE	Nipple TBE	Nipple TOE
8	0.05	0.06	0.13	0.14	0.03	0.03	0.21	0.20	0.06	0.05	0.08	0.06
10	0.06	0.07	0.25	0.27	0.06	0.06	0.27	0.31	0.08	0.06	0.11	0.09
15	0.13	0.14	0.36	0.37	0.08	0.08	0.46	0.49	0.13	0.09	0.16	0.10
20	0.21	0.20	0.53	0.60	0.15	0.15	0.61	0.80	0.17	0.12	0.22	0.16
25	0.37	0.30	0.78	1.08	0.24	0.24	0.99	1.31	0.24	0.18	0.31	0.23
32	0.60	0.73	1.02	1.22	0.37	0.37	1.55	1.61	0.33	0.24	0.44	0.35
40	0.73	1.03	1.70	2.45	0.45	0.45	1.90	3.20	0.40	0.30	0.53	0.40
50	1.10	1.35	2.35	2.50	0.76	0.76	2.86	3.55	0.53	0.40	0.74	0.56

TBE = Threaded Both Ends

TOE = Threaded One End

## Grade 304

Product range and theoretical weights (kg)					
DN	Coupling	90° Elbow	Hex nipple	Hex plug	Union
15	0.11	0.41	0.08	0.07	0.30
20	0.20	0.68	0.17	0.13	0.58
25	0.29	1.02	0.38	0.20	0.76
32	0.73	1.22	0.37	0.41	1.55
40	1.00	2.44	0.63	0.60	1.60
50	1.42	2.52	1.10	1.10	2.42

## Class 6000 and 9000

Higher pressure fittings are available subject to enquiry

## Screwed Class 3000 NPT 316 Fittings – ASTM A182M and ASME B16.11



Product range and theoretical weights (kg)				
DN	Hex reducing bush	Hex reducing nipple	Swage nipple TBE 80S	Reducing insert
8x6	0.02	0.05	0.04	0.04
10x6	0.02	0.06	0.06	0.05
10x8	0.03	0.06	0.06	0.05
15x6	0.04	0.08	0.14	0.10
15x8	0.06	0.08	0.14	0.10
15x10	0.06	0.08	0.18	0.10
20x8	0.08	1.15	0.18	0.12
20x10	0.07	0.17	0.18	0.12
20x15	0.05	0.17	0.18	0.12
25x8	0.12	0.38	0.25	0.16
25x10	0.14	0.38	0.25	0.16
25x15	0.12	0.38	0.25	0.16
25x20	0.12	0.38	0.25	0.16
40x15	0.21	0.63	0.60	0.45
40x20	0.21	0.63	0.60	0.45
40x25	0.21	0.63	0.60	0.45
40x32	0.21	0.64	0.60	0.45
50x25	0.45	0.68	1.14	0.70
50x40	0.50	0.70	1.14	0.70

TBE = Threaded Both Ends

**Class 6000 and 9000**

Higher pressure fittings are available subject to enquiry

**Socket Weld Class 3000 Fittings – ASTM A182M and ASME B16.11**



**Grade 316L**

Product range and theoretical weights (kg)						
DN	Cap	Coupling	45° Elbow	90° Elbow	Equal tee	Union
8	0.06	0.07	0.25	0.26	0.30	0.21
15	0.12	0.14	0.36	0.36	0.50	0.30
20	0.21	0.20	0.53	0.60	0.80	0.50
25	0.40	0.40	0.80	1.10	1.31	0.80
32	0.60	0.70	1.00	1.20	1.61	1.20
40	0.70	1.00	1.70	2.40	3.20	1.50
50	1.10	1.30	2.30	2.50	3.50	2.30

**Grade 316L Reducing Inserts**

Product range and theoretical weights (kg)			
DN	Reducing inserts	DN	Reducing inserts
20x15	0.12	40x25	0.45
25x15	0.16	50x25	0.7
25x20	0.16	50x40	0.7
40x20	0.45		

Class 6000 and 9000 higher pressure rated fittings are available subject to enquiry.

**Socket Weld Class 3000 Fittings – ASTM A182M and ASME B16.11****Grade 304L**

Product range and theoretical weights (kg)						
DN	Cap	Coupling	45° Elbow	90° Elbow	Equal tee	Union
8	0.06	0.07	0.25	0.26	0.30	0.21
15	0.12	0.14	0.36	0.36	0.50	0.30
20	0.21	0.20	0.53	0.60	0.80	0.50
25	0.40	0.40	0.80	1.10	1.31	0.80
32	0.60	0.70	1.00	1.20	1.61	1.20
40	0.70	1.00	1.70	2.40	3.20	1.50
50	1.10	1.30	2.30	2.50	3.50	2.30

**Branch Outlet Class 3000 304L and 316L – ASTM A182M and ASME B16.11**

Product range and theoretical weights (kg)						
DN	Socket outlet 304L	Threaded outlet 304L	Welding outlet 304L	Socket outlet 316L	Threaded outlet 316L	Welding outlet 316L
15	0.15	0.12	0.13	0.15	0.12	0.13
20	0.17	0.24	0.24	0.17	0.24	0.24
25	0.27	0.38	0.38	0.27	0.38	0.38
40	0.48	0.66	0.66	0.48	0.66	0.66
50	0.07	1.02	1.02	0.75	1.02	1.02

**Class 6000 and 9000**

Higher pressure fittings are available subject to enquiry